

INSTRUCTIONS

Commissioning guide for AHC-3000



Contents

1.	Introduction	4
2.	Screen-saver mode	5
2.1	Lost connection to the HMI-35 touch display.	5
3.	Home screen	5
4.	Password-protected settings.	6
5.	Selecting the language in the HMI	6
6.	Setting the current time and date	7
7.	Selecting system measuring units (°C, °F, m ³ /h, l/s, CFM)	8
8.	Fire settings	8
8.1	Fire alarm	9
8.2	AHU internal fire alarm	9
9.	Balancing	9
10.	Update SW and read out the current SW version	10
11.	Room info readout	11
12.	Alarm readout and reset.	11
13.	Communication set-up	12
13.1	Modbus TCP/IP – DHCP.	12
13.2	Modbus TCP/IP – Static IP	13
13.3	MAC address	13
13.4	Modbus RTU.	13
13.5	Bluetooth.	14
13.6	Cloud: activation, status and settings	15
14.	Configuring the application	16
14.1	Configuring the AHU type.	16
14.2	Configuring the temperature sensors	17
14.3	Configuring the filters	18
14.4	Autoconfigured pressure transmitters for flow and deicing	19
14.5	Autoconfigured drives and visualisation of the current power	20
14.6	Configuring the type of fan alarm detection	21
14.7	Configuring the heating.	22
14.8	Configuring the cooling.	23
14.9	Configuring the supply air: single-duct supply air system	24
15.	Autoconfiguring the AHU field components	25
16.	Autoconfiguration.	26
17.	Digital input configuration	27
17.1	Digital output configuration.	29
18.	Commissioning	30
18.2	Commissioning the heat recovery	31
18.4	Commissioning the cooler	33
18.5	Commissioning the temperature sensors.	34
18.6	Commissioning the CO ₂ sensors.	35
18.7	Commissioning the humidity sensors.	35

19.	Control settings	36
19.1	Fan control mode: Constant pressure	36
19.1.1	K-factor explanation	36
19.2	Fan control mode: Constant air flow	37
19.3	Fan control mode: Exhaust air slave	38
19.5	Fan control mode: Constant VOC/CO2	40
19.6	Fan control mode: Constant motor speed %	41
19.7	Air-control loop settings	42
19.8	Boost setpoint	42
19.9	Zero-calibrating the pressure transmitters	43
20.	Temperature control settings	44
20.1	Temperature control loop settings	45
20.2	Heating coil settings (Water coil)	46
20.3	Heating coil settings (Electric coil 1)	48
20.4	Combi settings (Water Combi coil, heat pump) heating	49
20.5	Combi coil settings (Water Combi coil, heat pump) cooling	50
20.6	Cooling coil settings (Water cooling coil)	51
20.7	Cross-flow heat-exchanger settings	52
20.8	Counter-flow heat-exchanger settings	53
20.9	Rotary heat exchanger settings	54
20.10	Summer night cooling (Free cooling)	55
20.11	Summer night cooling - With or without external outdoor- and room sensor	56
21.	Operation time schedule	57
21.1	Operation modes	57
21.2	Setting the active schedule period and fall-back speed	58
21.3	Setting standard daily operation pattern	59
21.4	Copy a daily schedule to one or more days	60
21.5	Scheduled operation exceptions	61
22.	BasicBMS	64
22.1	Introduction	64
22.2	Configuring BasicBMS Building Master network	64
22.3	Finishing the Modbus communication network	66
22.4	Common outdoor sensor	67
22.5	Setting up all Schedulers	67
22.6	Configuring the BMS Satellites network	68
22.7	Configure the AHU Satellites	68
22.8	Configure the AHU Satellites to the Building Master (BM) / Room Master (RM)	69
22.9	Allocation of satellite numbers	69
22.10	SW update process	70
22.11	How to delete a AHU Satellite from the network	70
22.12	How to add a new AHU Satellite to the network	71
22.13	Satellite control settings	71
22.14	Alarm handling from the AHU Satellites	72

**Note**

It is very important that all who gets in touch with the ACH-3000 system, whether you are manufacturer, installer, service technician or system integrator to read this commissioning guide thoroughly before start commissioning the AHC-3000.

This commissioning guide is intended to be used by the following individuals:

- The manufacturer/AHU producer
- The commissioning engineer
- The system integrator
- The installer
- The service technician
- The daily user – see www.ojelectronics.com

OJ cannot be held liable for any errors in catalogues, brochures or other printed material. OJ reserves the right to alter its products without notice. This also applies to products already on order, provided that such alterations can be made without requiring subsequent changes in specifications already agreed. All trademarks in this material are the property of the respective companies. OJ and the OJ logotype are trademarks of OJ Electronics A/S. All rights reserved.

1. Introduction

The ACH-3000 from OJ Electronics A/S is an intelligent and at the same time simple-to-use controller for air handling units. The OJ ACH-3000 system can control one air handling unit and, when connected in a network, it is possible to control and monitor up to 25 air handling units from a single HMI* display. *=**Human Machine Interface**

This commissioning guide provides valuable information when commissioning an ACH-3000 air handling unit at the factory. After the air handling unit is installed in the building, the installer and/or system integrator will also find essential information in this guide to get the air handling unit to work ideally and provide maximum comfort with minimum energy consumption.

For the manufacturer

The AHC-3000 has been developed with the aim of making the AHU controller set-up as easy and user-friendly as possible. The AHC-3000 has a number of pre-configured most frequently used AHU applications. The configuration is easily made with the new "Autoconfiguration" function and user settings is very easy to be made with the handheld 3½" HMI display.

For the commissioning engineer

Commissioning, setting the operation schedulers and optimising the energy of the AHC-3000 on-site is done very easily from the HMI touch display.

For the installer

For the installer on-site, all internal cabling, wiring and configurations have already been made at the factory. Therefore, all you need to do is turn on the power to the AHC-3000 AHU.

For the system integrator

The OJ AHC-3000 is one of the most flexible systems on the market in terms of BMS system integration. Standard features worth mentioning: The Modbus RTU & TCP/IP is built-in. The associated protocols can be downloaded from www.ojelectronics.com.

For the service technician

"On the AHC-3000-B, config-file and software update can be made from a Smart Phone."

For the user

The AHC-3000 has several interfaces, such as: OJ-Cloud, HMI-20T room touch display and the HMI-35 touch display from where the daily user can change temperature and operation settings and receive alarms. Basic settings are password protected.



Auto save function

After change of settings, just press “Back”. 
 Changes is automatically saved in the controller.

2. Screen-saver mode

If the HMI-35 display hasn't been touched for 60 seconds, the display will go into screen saver mode. The display will show the current status of the air handling unit: see fig. 2.1

Note! Flashing HMI:

If the HMI-35T is flashing (black/white screen), the SW in the HMI is being updated from the AHC-3000 controller.

Please wait two minutes until the flashing stops and the HMI-35T is ready to use.

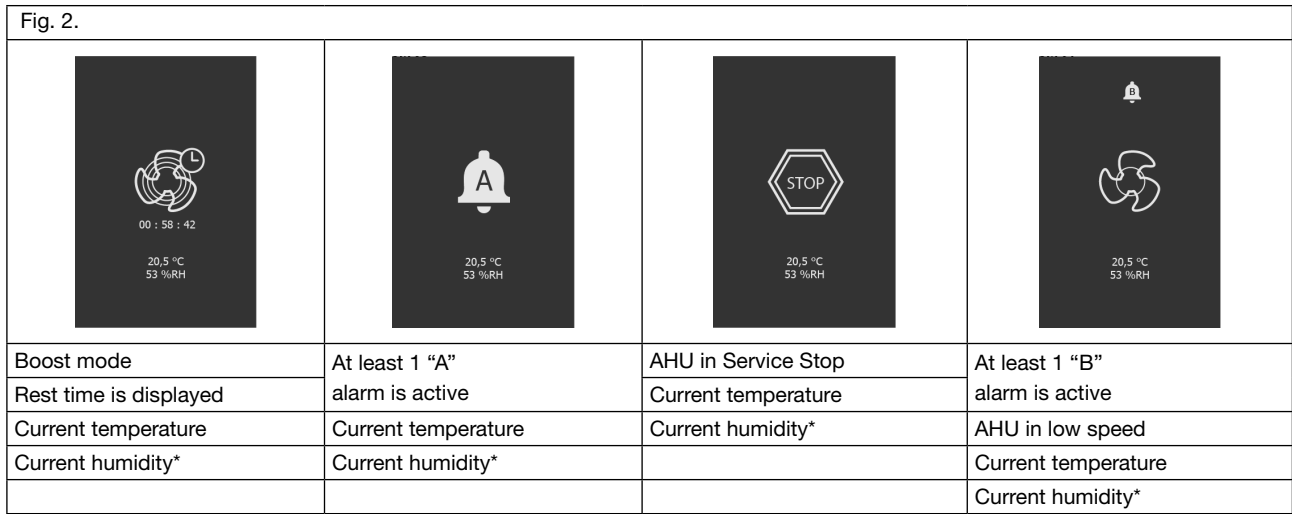

*=Only in humidity control mode

2.1 Lost connection to the HMI-35 touch display

If the display continuously show “Lost communication”: ⇨
 Check the connection between the controller and the HMI-35 display

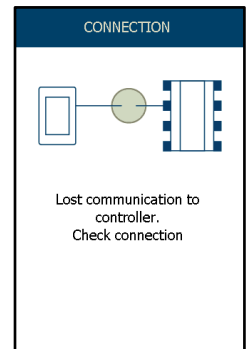

3. Home screen

When the display is in “Screen-saver mode”, one touch will start up the display. The first picture on a stand-alone unit - see sample below. From this window it is possible read out current values and make different entries and settings.

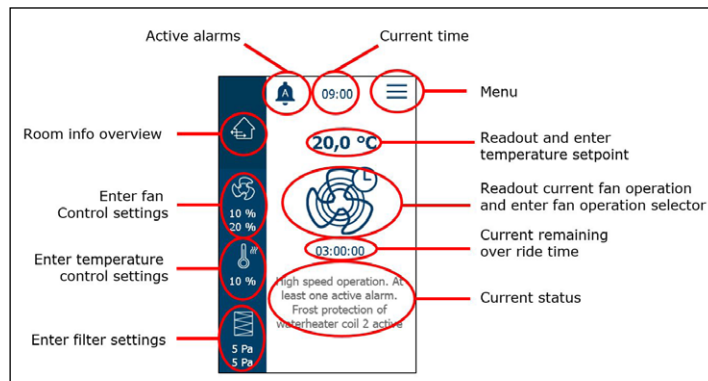



4. Password-protected settings

Some menus are password protected.

Settings like temperature setpoint, language, time and other similar user settings are not password protected.

Other installer and service menus may be protected by either a “Service password” or an “Installer/Service password”

- Service password = 1 1 1 1
- Installer password = 1 1 1 2

The password expires in 60 minutes without operation.

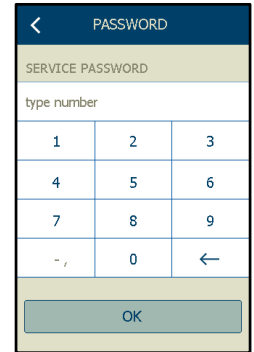
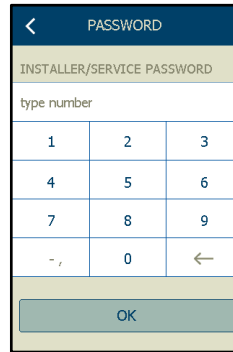

5. Selecting the language in the HMI

To start with, we suggest that you select your preferred language.

Enter the menu level via the “Menu” in the upper right corner of the home screen.

From here, select “Settings”

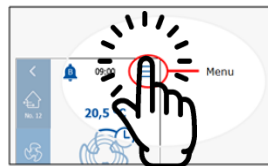

- Start on the Menu

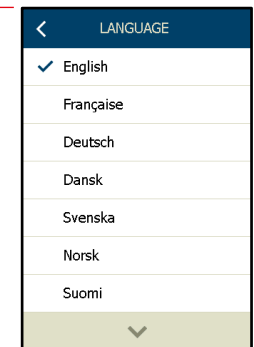
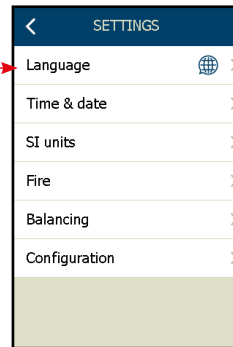
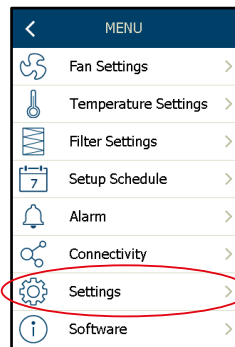

Fig. 4.3

Available languages: (see fig. 4.3)

- ⇒ English ⇒ Française ⇒ Deutsch
- ⇒ Dansk ⇒ Svenska ⇒ Norsk
- ⇒ Suomi ⇒ Español ⇒ Polski
- ⇒ Русский ⇒ Italiano ⇒ Nederlands

After selecting the preferred language, press “Back”

Your selection is automatically saved in the controller after selection.





6. Setting the current time and date

The local time and date must be set during the commissioning of the AHC-3000.

Without power, the AHC-3000's current time and date will be supported from a backup battery for at least 12 months.

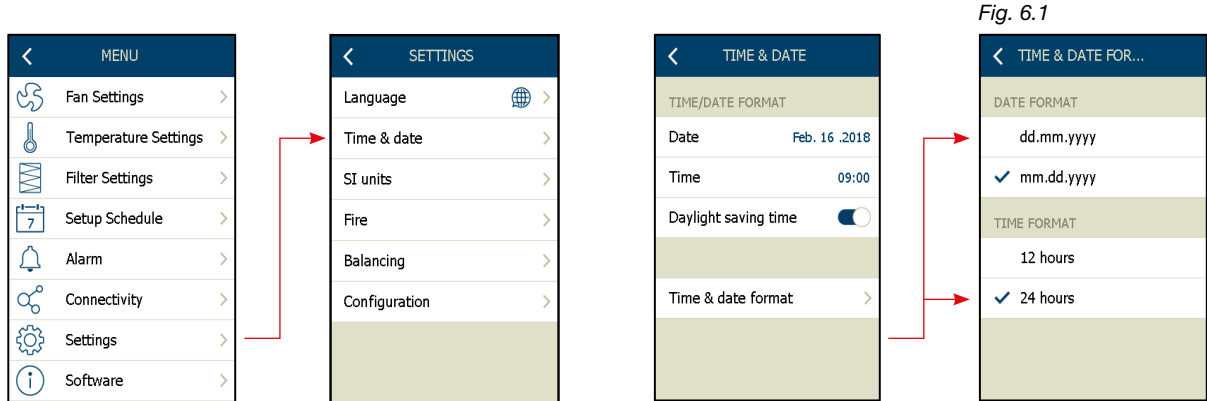
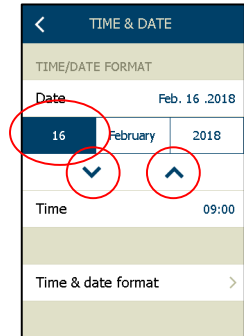

Fig. 6.1

Select the local area time and date format (see fig. 6.1)

If you want to set/change the current “Time and Date”, select the parameter (date, month, year) that you want to change by marking the current value field (see Fig.no. 6.2) and use the up and down buttons to make your individual adjustment for: date, month and year. Repeat this procedure for the current time.

Fig. 6.2



Auto daylight saving

Select Daylight saving time = “On”

Daylight saving will be activated according to the local daylight saving calendar

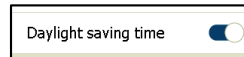

Auto save function

After setting the current time and date, press “Back”.

Your settings are automatically saved in the controller after selection.

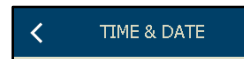



7. Selecting system measuring units (°C, °F, m³/h, l/s, CFM)

According to local demands, it is possible to select the measuring units:

Temperature units	
°C	Degrees Centigrade
°F	Degrees Fahrenheit
Air flow units	
m³/h	Cubic metres per hour
l/s	Litres per second
CFM	Cubic feet per minute

Fig. 7.1

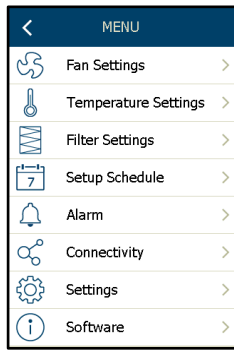

Fig. 7.2

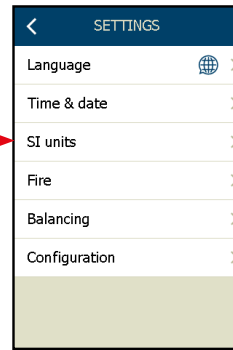
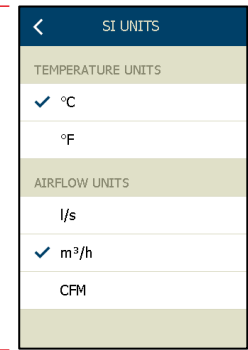
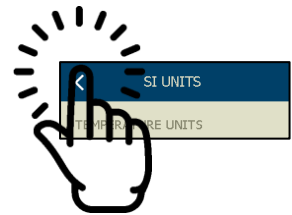

Fig. 7.3



Select °C or °F – only one selection is possible.
 Select l/s, m³/h or CFM – only one selection is possible.

After setting the measuring units, press “Back”.
 Your selection is automatically saved in the controller after selection.



8. Fire settings

The AHC-3000 supports two different kinds of fire alarm:

Fire alarm: detected from a fire thermostat or an automatic fire detection system (AFD).

Internal fire alarm: detected from the internal supply air and extract air temperature sensors.

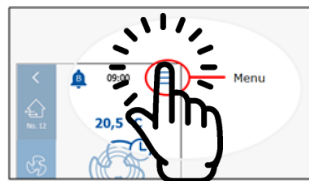

- Start on the Menu

Fig. 8.1

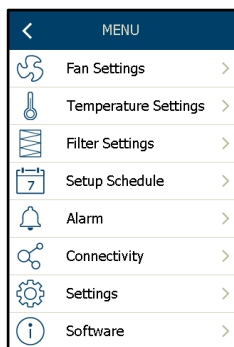

Fig. 8.2

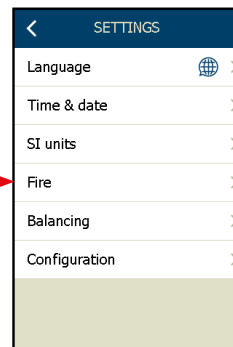
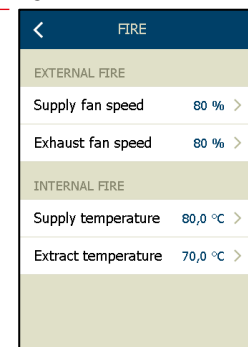



Fig. 8.3



Auto save function

After change of settings, just press “Back”. 
 Changes is automatically saved in the controller.



8.1 Fire alarm

This fire alarm is detected on the digital input: “External fire alarm”, on the AHC-3000 controller. The signal may possibly come from an automatic fire detection system (AFD) or an external fire thermostat or smoke detector, placed in the duct system.

If the digital input (External fire alarm) detects the fire alarm (fire alarm = open contact), the AHU will enter fire mode operation and the fan speed will assume the status selected in parameter “**Supply fan speed**” / “**Exhaust fan speed**” (see fig. 8.3, prev. page).

If a 0% fan speed is selected in both parameters, the AHU will stop and the dampers will close.

8.2 AHU internal fire alarm

This fire alarm uses the supply air and exhaust-air temperature sensors in the AHU to detect a fire alarm. If the current value of the “**Supply temperature**” or “**Extract temperature**” are beyond the setpoint (see fig. 8.3, prev. page), the AHU will go into fire alarm mode and emit a fire alarm: “A” alarm. This fire alarm will stop the fans.

9. **Balancing**

This function allows the installer to maintain a constant fan speed during the air-distribution adjustment of, for instance, the manual dampers in a CAV application.

Selecting “Lock fan” will set the fan speed at the current value.

The fans will remain at this speed for eight hours – and the system will automatically return to normal operation after this period of time has elapsed.

If the balancing job is finished before time runs out, you can manually return the function to “**Normal operation**”.

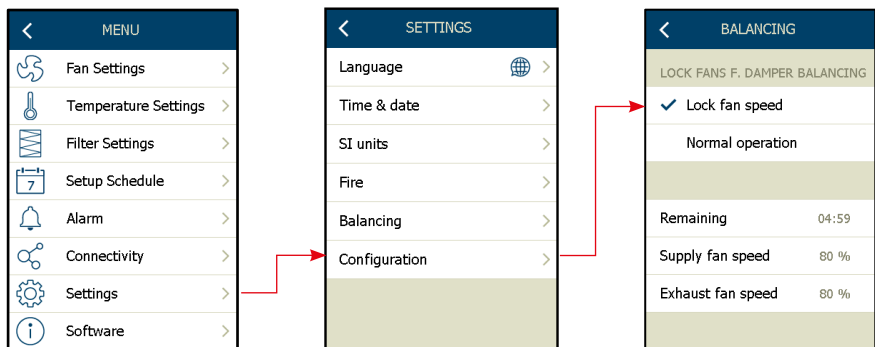

Info:

Frost protection of the water heating coil is active during the balancing function – the normal temperature control is active.



10. Update SW and read out the current SW version

To read out the SW version for the AHC-3000 and the connected HMI-35T

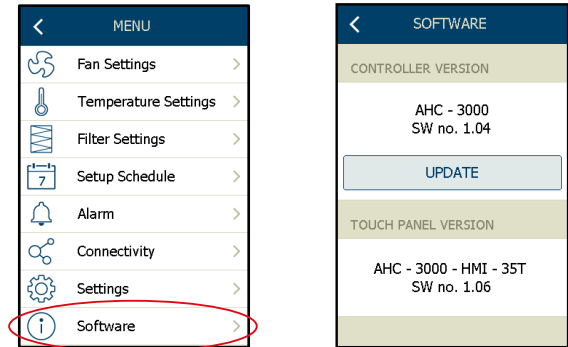

Updating the SW

To update the SW in the AHC-3000 and in the HMI-35T hand-held terminal, the updating SW must be downloaded to the AHC-3000 controller using:

- OJ Air PC Tool
- OJ Air Service tool APP
- OJ-Air Cloud

When the “Update button is visible in the “Software” menu, the new SW was successfully downloaded to the AHC-3000 controller.

The new SW package, contains actually 2 SW-packages:

- 1) Controller SW
- 2) HMI-35-T SW

After the new SW package has been downloaded to the AHC-3000 controller, the new SW must be activated.

To activate the new in the AHC-3000 controller, either power off the controller for at least ten seconds or press: ⇨

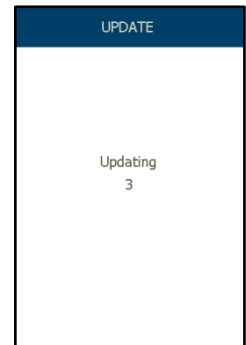

The update progress can be followed on the HMI-35T...

The SW-activation process has successfully completed, when the LED on the PCB, upon the power terminals (ø45/46), do flash green.

Before you proceed to next step: To activate the new SW in the HMI-35T - it is very important you check, that the LED on the PCB do flash green.

HMI-35T software must be activated according to below activation process:

- Remove the HMI-35T from the “HMI” plug on the AHC-3000 controller
- Power off the AHC-3000 controller
- Wait min. 10 seconds
- Power up the AHC-3000 - wait until the LED on the PCB do flash green
- Hot-plug the HMI-35T handterminal, in the “HMI” plug on the AHC-3000 controller

While the HMI-35T SW-update is in process, the HMI-35T display will flash for approximately 30 seconds.



Note

When the update button is activated, the AHU will go into operating mode: “Service stop”. ⇨

When the new software is active in the AHC-3000, the “Update” button disappears, and the new software versions are displayed. The AHU will remain in operating mode, “Service stop”, until another operating mode is selected.



11. Room info readout

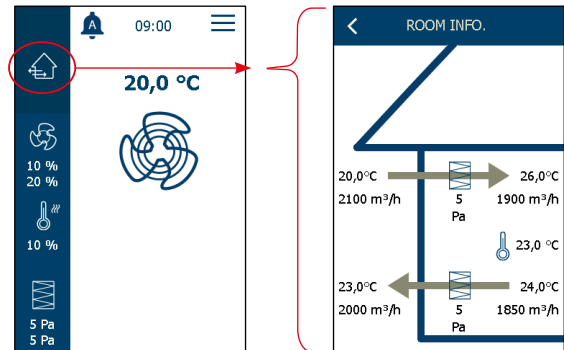

A simple status overview for the AHU system can be displayed by selecting ⇨





Depending on the configuration, the current status and values will be displayed:

- ✓ Current value on all temperatures in the AHU
 - Only mounted and configured temperature sensors will be displayed
- ✓ Current room temperature
 - Only displayed if room sensor is connected and configured
- ✓ Current value on all measured air flow in the AHU
 - Current value is only displayed if pressure transmitters for flow measurement, are connected and configured.
- ✓ Current filter pressure drop on all measured filters in the AHU
 - The current pressure (Pa) will be displayed if a pressure transmitter is installed across the filters

12. Alarm readout and reset

If an alarm bell is displayed on the overview picture, one or more alarms are active in the system.

 = One or more “A” alarms and possible “B” alarms

 = One or more “B” alarms

To enter the alarm overview, press the alarm bell symbol.

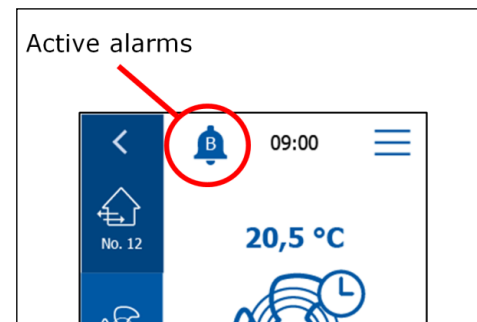



Reset alarms:

Clear Alarms will clear all active alarms.

After activating “Clear alarms”, any alarms still active in the system will be re-triggered and shortly after show up again in the alarm overview.

Up to 16 active and logged alarms will be listed.

Alarm details and description:

Select the actual alarm (*1)

Latest cleared alarms will be listed in the alarm log: “Log date & alarm number” (*2)

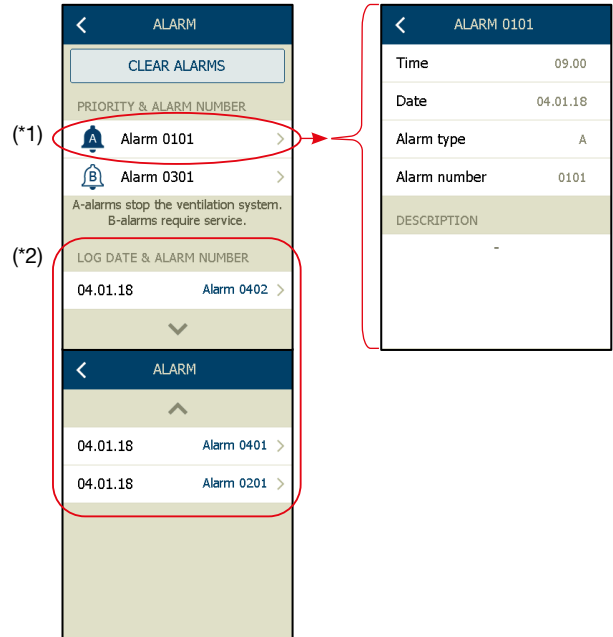

13. Communication set-up

The AHC-3000 can communicate on:

- a BMS system via Modbus TCP/IP and Modbus RTU
- Directly connected to a computer via a LAN cable (RJ45)

The AHC-3000 can also be connected to the OJ Cloud via the internet or a mobile app via Bluetooth

13.1 Modbus TCP/IP – DHCP

If the AHC-3000 is connected to a local area network (LAN) with a DHCP server, select “**Dynamic IP**” under the menu “**Static/Dynamic IP**”

The DHCP server will automatically set all the necessary information in the AHC-3000, including: IP address, Netmask, Gateway and DNS.

As soon as the AHC-3000 receives an IP address, Netmask, Gateway and DNS from the DHCP server, this information will be found in the menu below.

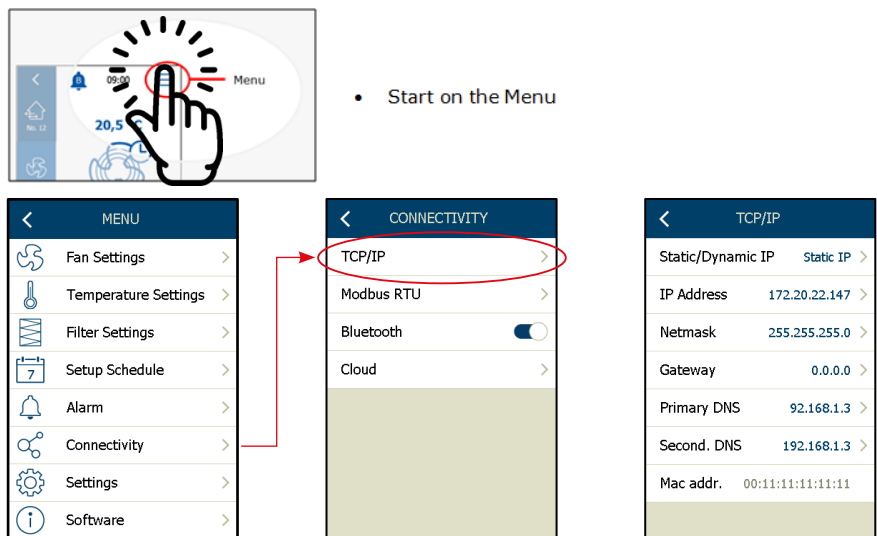



13.2 Modbus TCP/IP – Static IP

If the AHC-3000 is connected to a stand-alone network without a DHCP server, or via a normal patch cable to a local computer, select “**Static IP**” under the menu “**Static/Dynamic IP**”.

After selecting “**Static IP**”, specify the IP-address and the Netmask. Normally it is not necessary to specify the Gateway, Primary and Secondary DNS. These values are normally sent automatically from the AHC-3000 after connection.

If the AHC-3000 is connected to a local computer: Remember to adapt the settings on your computer to the settings on the AHC-3000.

If the local IT department has reserved a specific fixed IP-address for the AHC-3000, also select “**Static IP**”. After selecting “**Static IP**” specify the correct communication settings, such as: IP-Address, Gateway, Primary and Secondary DNS. You will receive this information from the local IT department.

13.3 MAC address

MAC address is a static number issued by OJ Electronics A/S. It cannot be changed.

13.4 Modbus RTU

If the AHC-3000 is connected to a BMS system which is a communication Modbus RTU, you must specify the communication parameters like:

- Basic BMS*
- Modbus address
- Baud rate
- Parity
- Number of stop bits

*=Activating "Basic BMS", will change the HMI-35 to "Basic BMS" settings - see index 22.

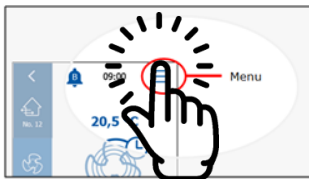

- Start on the Menu

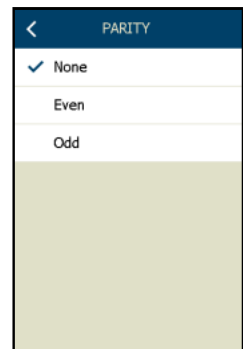
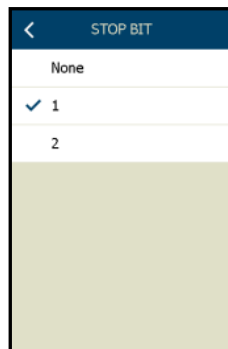
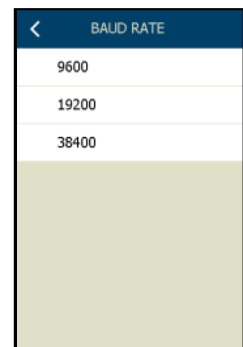
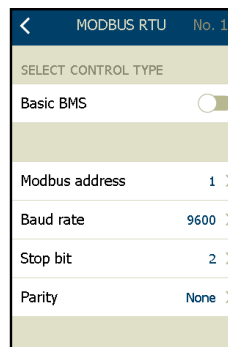
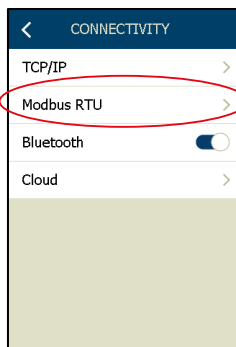
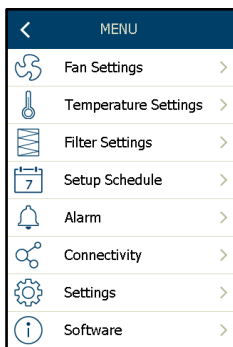

The AHC-3000 is connected to the BMS Modbus network via the RJ12 plug connector marked “**BMS Modbus RS485**”, using a RJ12 patch cable.

Auto save function

After change of settings, just press “Back”.



Changes is automatically saved in the controller.



13.5 Bluetooth

To use Bluetooth you must use the type AHC-3000-B.

Download the “OJ Air Service Tool app” from you app provider.

Bluetooth must be activated in AHC-3000-B before use.

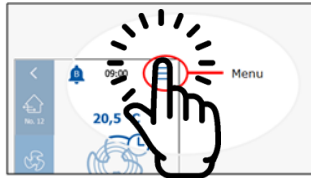

- Start on the Menu

• **Bluetooth**

Activating the Bluetooth in the AHC-3000-B, and the controller will be visible in the **OJ Air Service Tool app**

• **Bluetooth pairing**

Enable Bluetooth pairing and the AHC-3000 will auto connect your device.

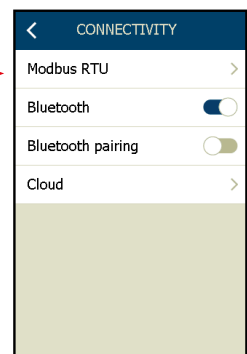
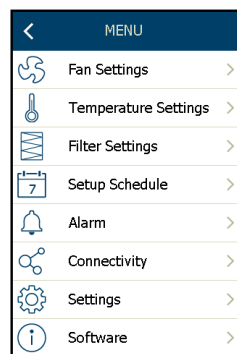

It is possible to use the AHC-3000 app for file handling:

- Software update
- Save and load parameter settings
- Data logging

and/or

- Cloud gateway

All nearby available AHC-3000-B, are displayed in the list.

Last 5 digits in the ID number, refers to the manufacturer production information. Same number can also be found as a part of the production ID on the silver label on the side of the AHC-3000-B controller.

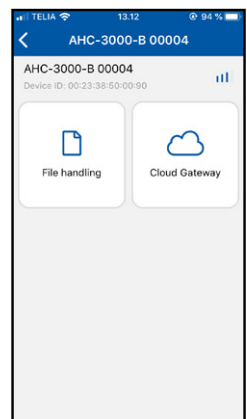
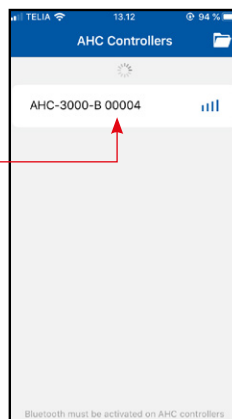



13.6 Cloud: activation, status and settings

To permanently connect the AHU to the OJ-Cloud, use the type ACH-3000-T and connect it to the Internet (see index 13.1 & 13.2).

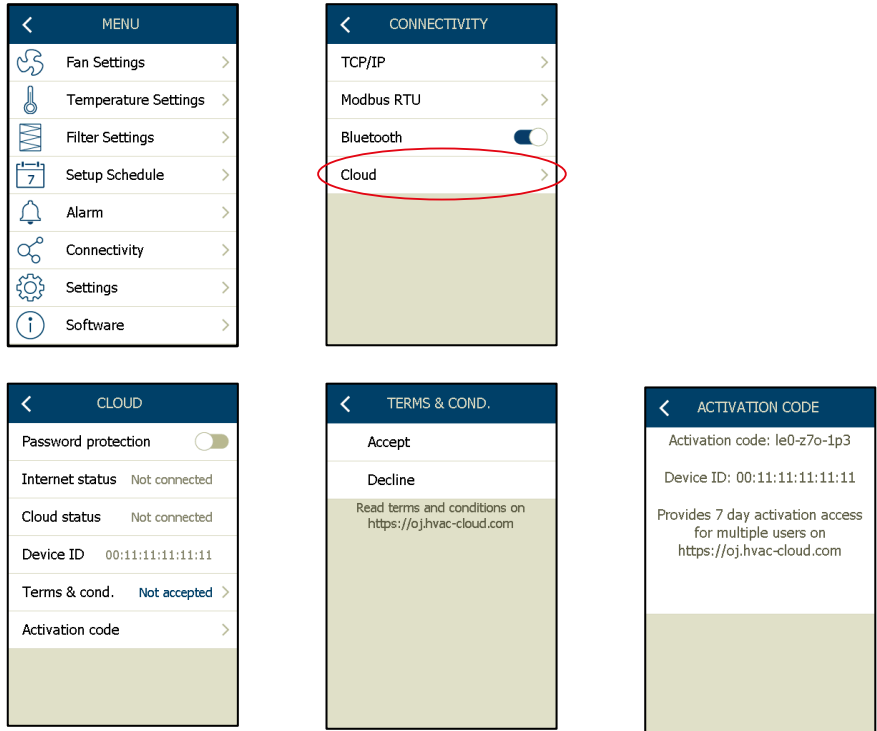

Password protection

√ Select password protection (On/Off)

Internet status

√ Status on the Internet connection (No cable/Connecting/Connected/Error)

Cloud status

√ Status of the cloud connection (Not connected/Connecting/Connected/Access denied/Error)

Device ID

√ Device ID on the AHC-3000 controller

Terms & conditions

- √ You must accept the Terms & Conditions before the AHC-3000 will connect to the OJ Air Cloud®
- √ Terms & Conditions are available on <https://oj.hvac-cloud.com>

Note! After accepting the Terms & Conditions, the AHC-3000 will start uploading data to OJ Air Cloud®

Activation key

√ Read out the activation key. This must be used to log on to your OJ Air Cloud® account.

Note! Find more information for OJ Air Cloud® on: <https://oj.hvac-cloud.com>



14. Configuring the application

Now we will start to configure the application.

First, select the AHU type from among these main categories: 1) Rotor heat exchanger 2) Counter-flow heat exchanger 3) Cross-flow heat exchanger, 4) Mixing 5) Supply 6) Extract.:



Note

If the selections in the "AHU type menu" is changed, during running operation mode, the AHU will automatic be forced into operation mode "Service stop". The new selections will automatic be saved.

After the new selections has been made, the AHU will remain in operation mode "Service stop" and you must re-activate the new operation mode, from the main menu on the HMI-35 display.

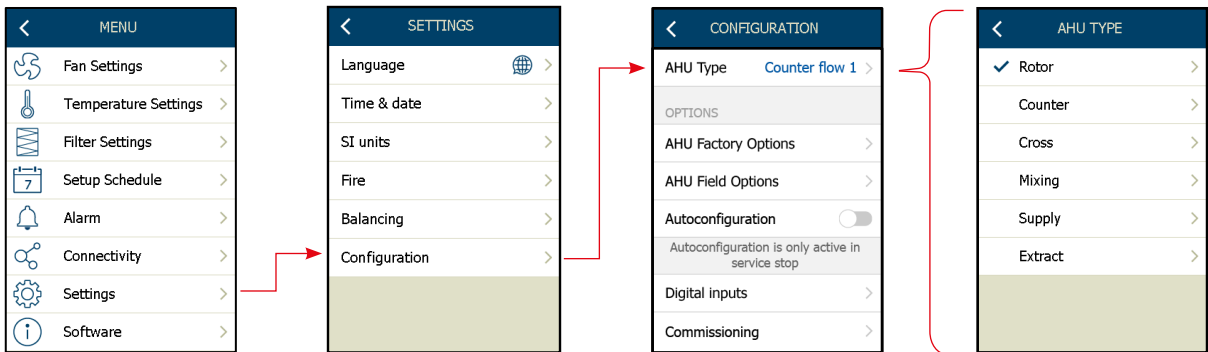

Fig. 14.1

14.1 Configuring the AHU type

Here, select the type of AHU (see fig. 14.1)

After selecting the AHU type, select the size* of the AHU (see fig. 14.2.....14.7)

*Size is the max. volume of the AHU in m³/h

A number of predefined AHU sizes are listed:

Fig. 14.2

Fig. 14.3

Fig. 14.4

Fig. 14.5

Fig. 14.6

Fig. 14.7

Rotor	Counter flow	Cross flow	Mixing box	Supply air	Extract air

Auto save function

After change of settings, just press "Back".



Changes is automatically saved in the controller.



14.2 Configuring the temperature sensors

Here, select the temperature sensors in the AHU from among these options:

- PT-1000*
- NTC 12K
- Supply air temperature*¹
- Outdoor air temperature*¹
- Exhaust air temperature*²
- Extract air temperature*²
- Water temperature*

*=Factory setting - Dual duct
¹=Factory setting - Supply air only
²=Factory setting - Extract/exhaust air only

All air-temperature sensors are pre-selected from the factory. Only the water temperature is auto selected if a water heating battery is configured.



Note

The AHU must be in operation mode: “Service stop” from main screen menu, in order to activate the new settings.



14.3 Configuring the filters

Here select the filter monitoring from among these options:

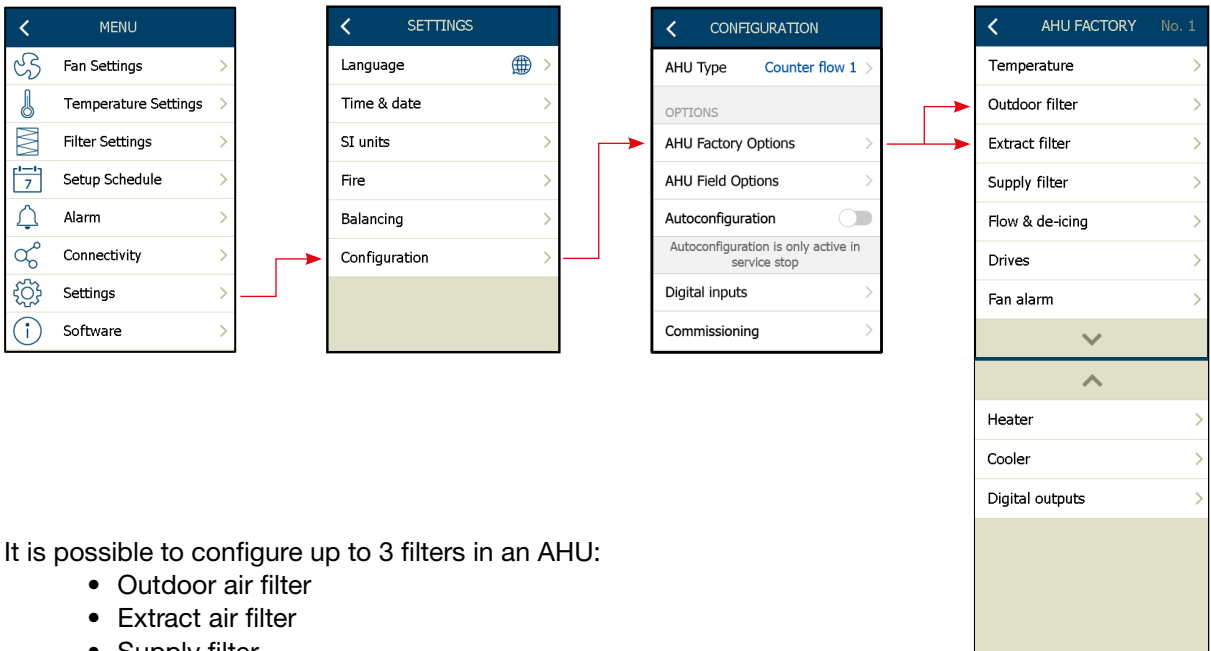

It is possible to configure up to 3 filters in an AHU:

- Outdoor air filter
- Extract air filter
- Supply filter

Filter alarm outdoor and extract air filter

- No filter alarm = No check mark
- Timer function
- Filter switch NO; Leads to: DigIn Closed=Alarm
Filter switch NC; Leads to: DigIn Open=Alarm
- Static filter alarm; via pressure transmitter
- Dynamic filter alarm; via pressure transmitter*

Filter alarm supply air filter

- Timer function
- Switch NO
- Switch NC

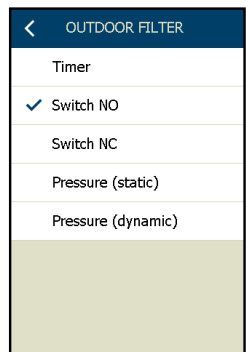

Filter alarm settings, is made from the "Filter settings" menu or via the filter symbol on the main screen.

* Requires flow measurement on the fans.



Note

The AHU must be in operation mode: "Service stop" from main screen menu, in order to activate the new settings.



14.4 Autoconfigured pressure transmitters for flow and deicing

Here you see the autoconfigured flow & deicing pressure transmitters:

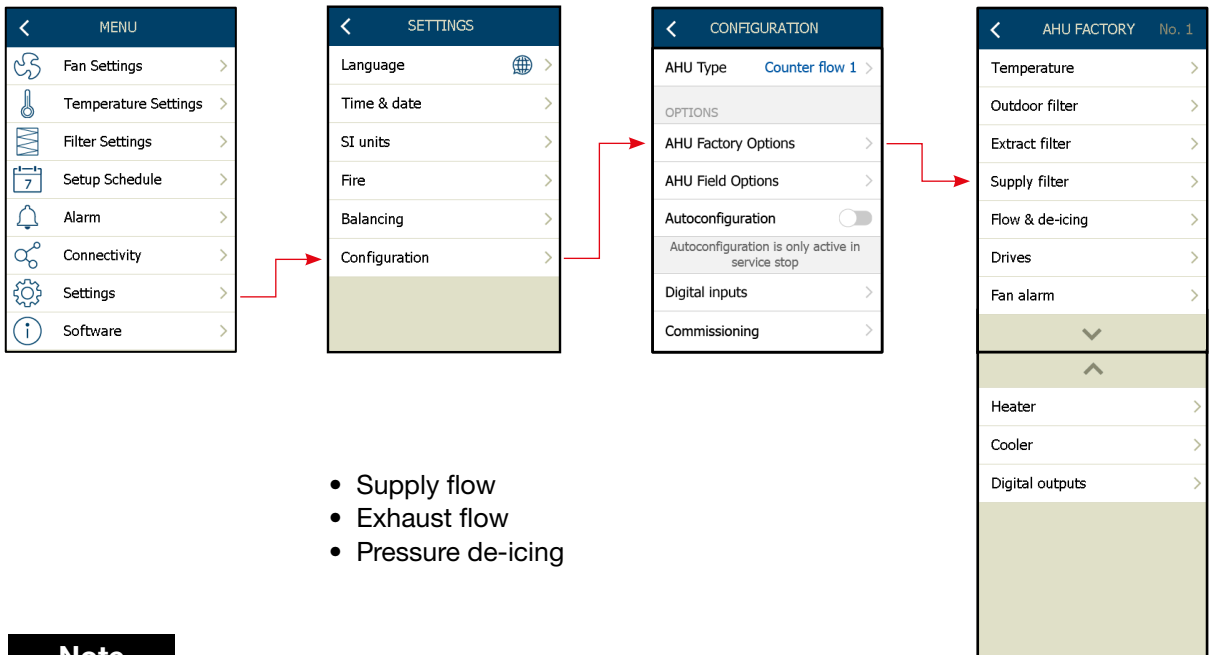

- Supply flow
- Exhaust flow
- Pressure de-icing



Note

The 3 pressure transmitters:

- √ Supply flow
- √ Extract flow
- √ Pressure de-icing

- are all auto mounted via Modbus communication, when executing the “Autoconfiguration” process. This window is only a visualization of which pressure transmitters is found active connected on the Modbus communication, during the “Autoconfiguration” process. The connected pressure transmitters are for measuring the flow volume of the fans and the pressure drop (Pressure de-icing) over the heat exchanger*.

*=Only cross- and counter flow heat exchanger.

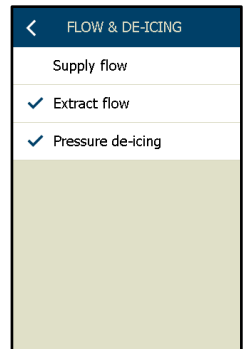



14.5 Autoconfigured drives and visualisation of the current power

Here you see the autoconfigured drives which can display the current power consumption.

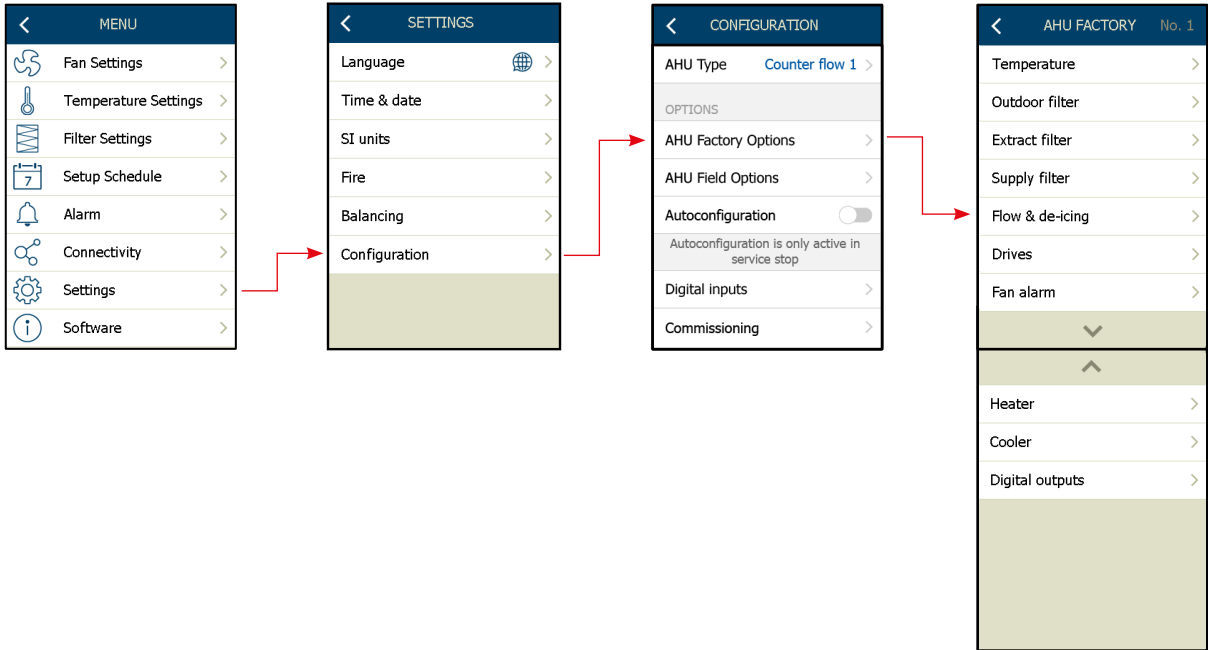

- Rotor DRHX
- Supply fan DV
- Exhaust fan DV



Note

This 3 drives are all auto mounted via Modbus communication, when executing the “Autoconfiguration” process. This window is only a visualization of which drives components is found active connected on the Modbus communication, during the “Autoconfiguration” process.

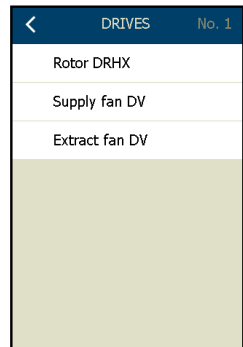



14.6 Configuring the type of fan alarm detection

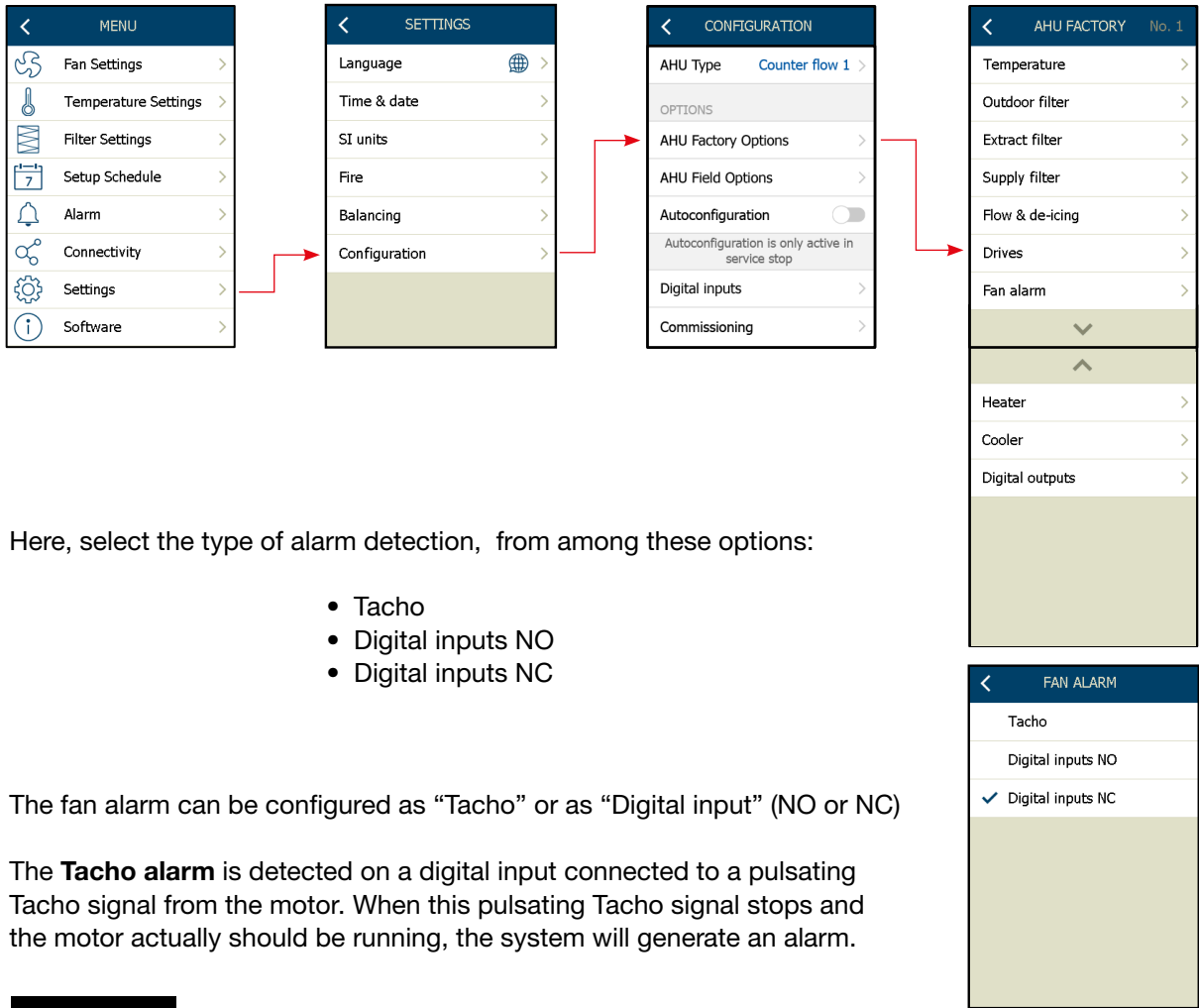

Here, select the type of alarm detection, from among these options:

- Tacho
- Digital inputs NO
- Digital inputs NC

The fan alarm can be configured as “Tacho” or as “Digital input” (NO or NC)

The **Tacho alarm** is detected on a digital input connected to a pulsating Tacho signal from the motor. When this pulsating Tacho signal stops and the motor actually should be running, the system will generate an alarm.



Note

Tacho can only be used on digital input 1 and digital input 2.

Fan alarm can also be made via an alarm relay output on the motor/drives. Connect the alarm relay on the motor/drives, to a digital input on the AHC-3000 controller.

Depending on the relay output on the motor/drives, the relay might have status “open” or status “closed”, when the motor/drives is in alarm status. The selection in this menu (NO/NC), will take effect on both fans.

Digital inputs NO: When the digital input is “closed” the system will generate an alarm.

Digital inputs NC: When the digital input is “open” the system will generate an alarm.



Note

When the alarm type is selected, the fan alarm type, is applicable for both supply and exhaust air fan. Individual fan alarm type, for supply- and exhaust air fan, is not possible.



14.7 Configuring the heating

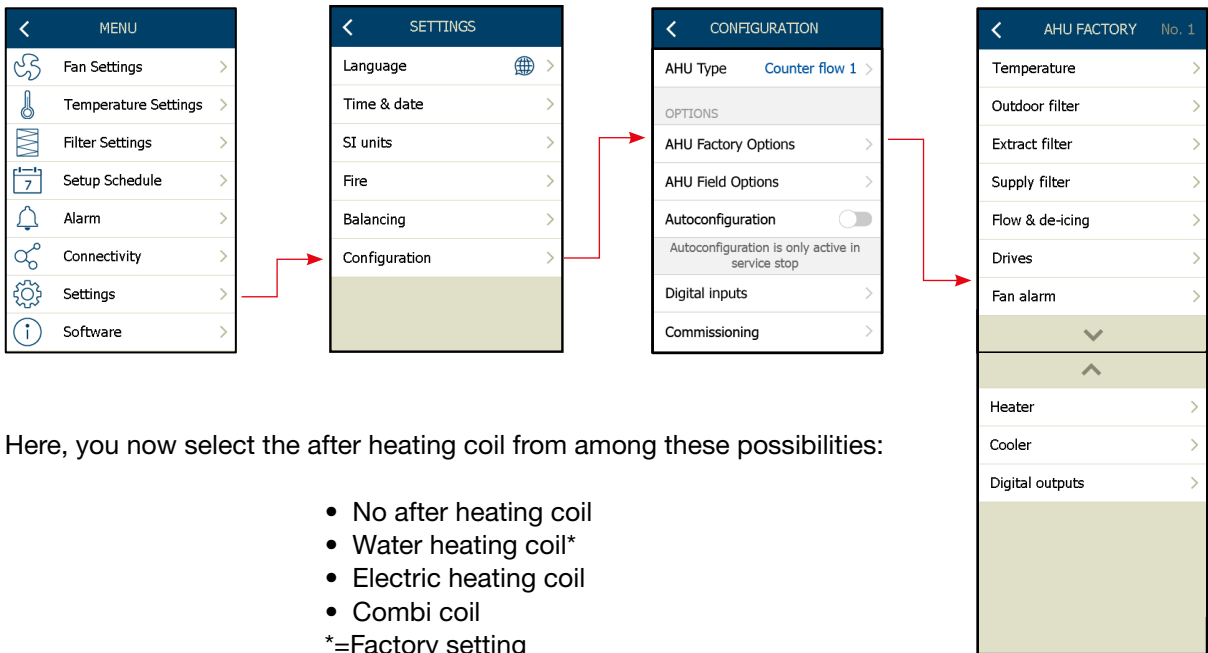

Here, you now select the after heating coil from among these possibilities:

- No after heating coil
- Water heating coil*
- Electric heating coil
- Combi coil

*=Factory setting



Note

On a stand alone AHC-3000 controller, it is only possible to configure one single coil (heating, cooling or combi coil).
 New selections, will overwrite previous selections.
 More than one single coil, requires an extension module (OJ-Air2EXT)



Note

If the selections in the “Heater menu” are changed during running operation mode, the AHU will automatic be forced into operational mode “Service stop”.
 The new selections will automatic be saved.
 After the new selections has been made, the AHU will remain in operational mode “Service stop” and you must re-activate the new operation mode from the main menu on the HMI-35 display.

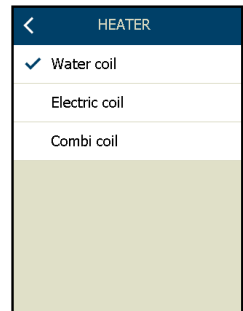

Note

When “Water heating” is selected, the digital output for circulation pump and frost protection of the heating battery is automatic selected. Frost protection will default be done through the temperature sensor on the return water.
 The return water sensor can be deselected under the menu: “Temperature”
 Frost protection settings is to be done in the water heating coil menu.
 Frost protection is also available through a capillary tube alarm (Frost thermostat). If you want to make the frost protection using a frost thermostat, you must assign a digital input under “Digital inputs”.

Note! When the water heating coil is configured on the extention module (EXT#3), the frost protection via digital input cannot be de-selected. If you don’t have a digital frost protection thermostat available in the applicaton, you must build in a bridge on the EXT#3, Din#2, to avoid ghost frost alarm. Return water sensor on the EXT#3, Tin#1, can be selected and de-selected. When selected, the frost protection on the water heating coil will be made in a comination between the return water sensor and the frost protection thermostat on the EXT#3, Din#2. It is not posible to configure combi coil nor electric heating coil on the extention module (EXT#3).

Warning:

If the frost protection sensor is deselected and no capillary tube alarm (frost thermostat) is configured, the AHU-3000 will generate an ”A”-alarm no. 1608: ”No active frostprotection configured.”



14.8 Configuring the cooling

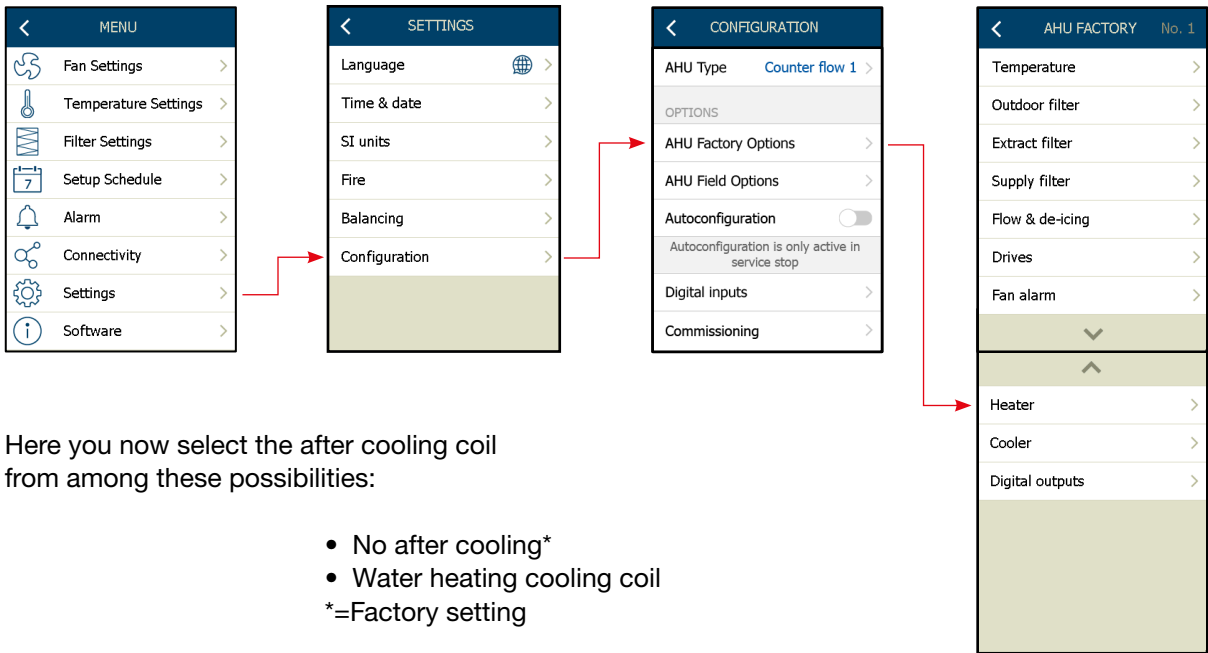

Here you now select the after cooling coil from among these possibilities:

- No after cooling*
 - Water heating cooling coil
- *=Factory setting



Note

On a stand alone AHC-3000 controller, it is only possible to configure one single coil (heating, cooling or combi coil)
New selections will overwrite previous selections.



Note

If the selections in the “Cooler menu” are changed during running operation mode, the AHU will automatic be forced into operational mode “Service stop”. The new selections will automatic be saved. After the new selections has been made, the AHU will remain in operational mode “Service stop” and you must re-activate the new operation mode from the main menu on the HMI-35 display.

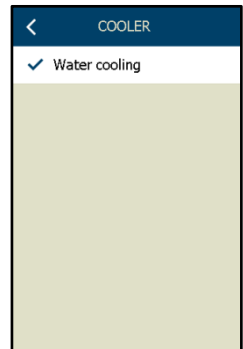

Warning

Frost protection has to be solved, using frost protected liquid in the water cooling battery.



14.9 Configuring the supply air: single-duct supply air system

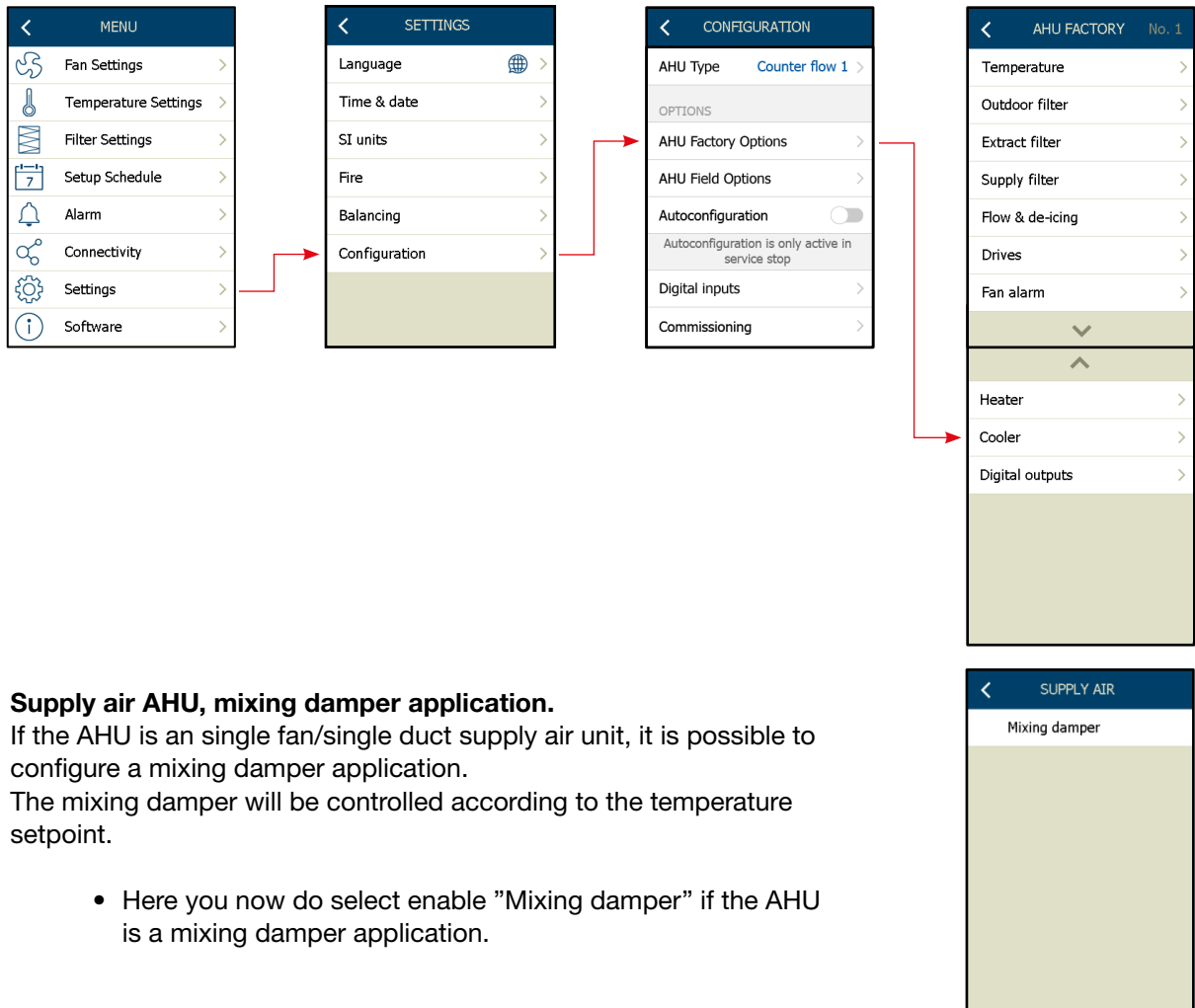

Supply air AHU, mixing damper application.

If the AHU is an single fan/single duct supply air unit, it is possible to configure a mixing damper application.

The mixing damper will be controlled according to the temperature setpoint.

- Here you now do select enable "Mixing damper" if the AHU is a mixing damper application.



15. Autoconfiguring the AHU field components

This shows the autoconfigured Air Handling Unit field options

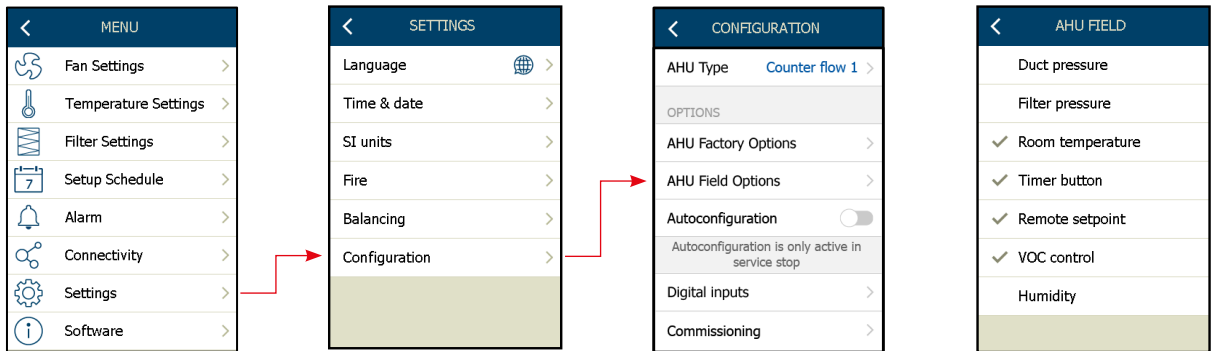

- Duct pressure
- Filter pressure
- Room temperature
- Timer button
- Remote setpoint
- CO2 control
- VOC control
- Humidity

All field options, functions and components are auto selected when the sensor(s) are detected during "Autoconfiguration".

This means that as soon as an pressure transmitter, VOC sensor, humidity sensor or HMI-20T room display has been detected on the Modbus during "Autoconfiguration", the sensor and the including function will be activated.

Example 1:

An HMI-20T is connected to the Modbus port via the RJ12 port marked "A".
As soon as the HMI-20T is detected on the Modbus, the functions:

- √ Room temperature
- √ Timer button
- √ Remote set-point

- will automatically be selected

Example 2:

An VTH-6202 VOC sensor is connected to the Modbus port via the RJ12 port marked "B".
As soon as the VTH-6202 is detected on the Modbus, the functions:

- VOC control

- will automatically be selected



16. Autoconfiguration

Autoconfiguration is a function in the AHC-3000 system that helps the commissioning technician configure the application.

The “Autoconfiguration” function scans the system and automatically detect all Modbus components in the AHU connected to ports “A”, “B1” & “B2”.

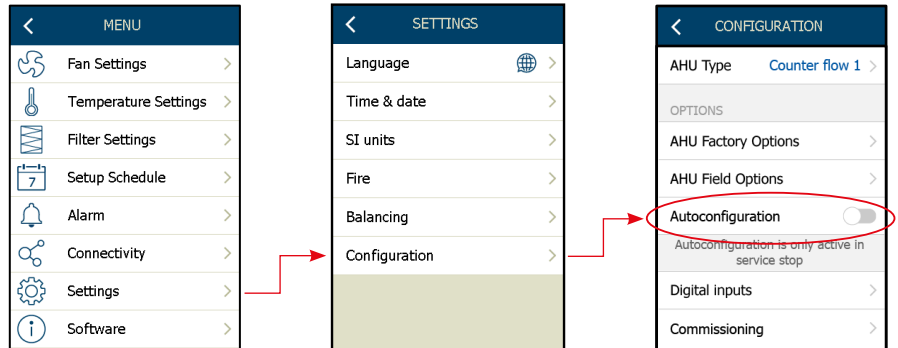

Note

When the “Autoconfiguration” button is activated, the AHU will go into operational mode: “Service stop”. ⇨



After 20 seconds, the scan of the Modbus has finished and the “Autoconfiguration” button must manually be released (set off) again.

After the Autoconfiguration button manually has been released, the AHU will remain in operation mode: “Service stop, until another operation mode is selected.



Note

When the “Autoconfiguration” button is activated, this information: “Autoconfiguration active”, will be displayed on the main menu screen, on the HMI-35 display.



The “Autoconfigure” function will now start a system scan.

All components on the Modbus:

- OJ-DV and DRHX drives
- PTH pressure transmitters
- Extension modules
- Modbus sensor (temperature, VOC sensor, humidity sensors)
- User interfaces (HMI-20-T room panel)

During “Autoconfiguration”, all the above types and models of Modbus components will be detected, integrated in the configuration and the attached function will be activated.



17. Digital input configuration

Configuring the digital inputs is made here.

Digital inputs can be used for pre-defined functions according to the application.

The digital inputs can be used for:

Supply fan alarm

- Fan alarms can be configured as “Tacho” or a digital alarm signal (NO/NC). See index no. 14.6.
- If “Tacho”* is selected, an alarm will be triggered if the tacho signal stops during fan operation.
* =Tacho is only possible on Din1 & Din2
- If “Digital input” is selected, an alarm will be triggered if the digital input is closed (NO)/open(NC).

Exhaust fan alarm – see the description above

Filter alarm – (common alarm)

- Filter alarm can be configured as a common digital signal for filter switches across the outdoor air filter and the extract air filter. The alarm will appear as “Filter alarm”.

Outdoor filter alarm

- Filter alarm using filter switch across the outdoor filter. The alarm will appear as “Outdoor air-filter alarm”. Alarm = Closed Din.

Extract filter alarm

- Filter alarm using a filter switch across the extract filter. The alarm will appear as “Extract air filter alarm”.

Supply filter alarm

- Filter alarm using a filter switch across the supply filter. The alarm will appear as “Supply air filter – pressure switch – active”

External fire alarm

- This fire alarm input will activate the fire running conditions as described under “Fire settings” (see index 8 of this manual).
- The alarm will appear as “External fire alarm”. Alarm = Open Din.

Frost alarm

- Digital input for the frost thermostat at the water heating coil. Alarm = Open Din.

Electric heater alarm

- Overheating thermostat on the electrical heating coil. Alarm = Open Din.

Summer/winter

- External signal for warm or cold water available for the combi battery (External heat pump)
 - Winter = Open Dig. input = Warm water available/No cold water available
 - Summer = Closed Dig. input = Cold water available/No warm water available

Start

- External start signal. AHU will start when the digital input is closed.

Boost speed

- External boost signal. Activation will increase the fan speed to boost speed (see index 19.8)
- AHU will boost as long as the digital input is closed

Smoke (stop)

- Signal from a smoke detector will stop the AHU. The alarm will stop the AHU and appear as "Smoke alarm". Alarm = Open Din.

Cooler alarm

- Alarm signal from the cooler (e.g. the cooler pump)
- Alarm = Open Din.

Heatpump Oil/Defrost

- Closed input shall lock the combi coil 0-10v output at current value if the heat pump is in operation.

Ext. fire thermostat

- Open input shall activate External fire thermostat alarm and the AHU will stop.

High speed

- Closed input shall activate high speed

17.1 Digital output configuration

Configuring the digital output is made here.

Digital output can be used for pre-defined functions according to the application.

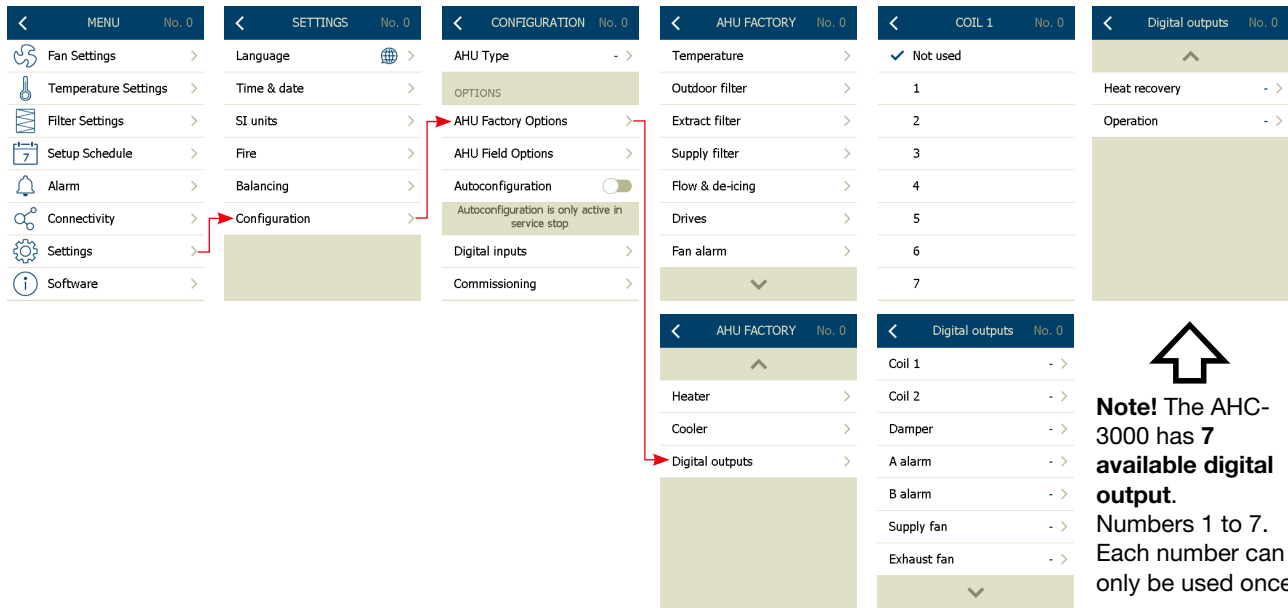

Coil 1

- Coil 1 is used for EI heater 1, heating, cooling or combi coil heating (NO)

Coil 2

- Coil 2 is used for EI heater 2 or combi coil cooling (NO)

Damper

- Digital output for Damper (NO)

A alarm

- Digital output for A alarm (NO)

B alarm

- Digital output for B alarm (NO)

Supply fan

- Digital output for supply fan (NO)

Exhaust fan

- Digital output for exhaust fan (NO)

Heat recovery

- Digital output for heat recovery (NO)

Operation

- Digital output for operation (NO)

Note! The AHC-3000 has 7 available digital output. Numbers 1 to 7. Each number can only be used once.

The last selection will overrule previous selections.



18. Commissioning

From this window, it is possible to commission and test the field components:

- Read out and override the status values of:
 - Supply air fan – Override not possible in operational mode “**Stop**”
 - Extract air fan – Override not possible in operational mode “**Stop**”
 - Heat recovery
 - Heating coil
 - Cooling coil
 - Sensor current value and sensor correction



Note

No override is possible in operation mode “**Service Stop**” 18.1 Commissioning the fans

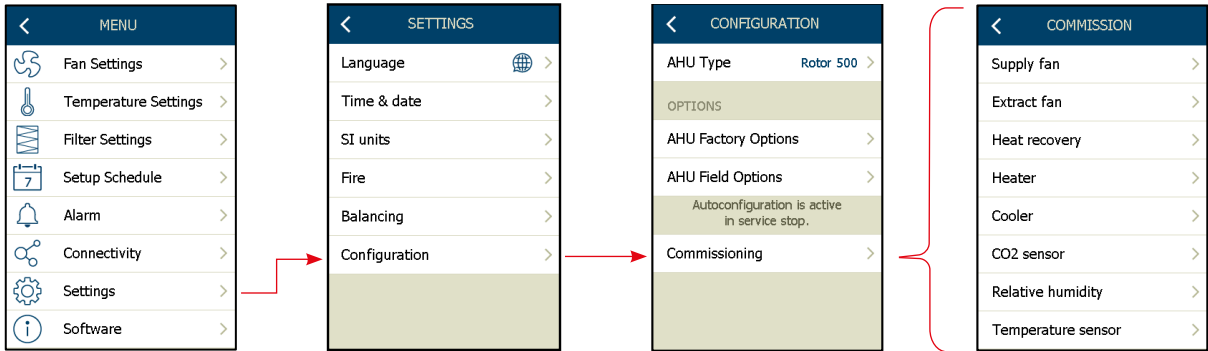

Fans status:

Settings:
Override On/Off

Status:
Current speed
Current fan pressure*
Status start relay
* = Only if configured

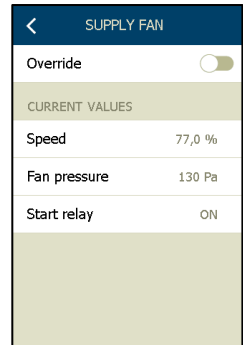

Fans override:

Activate the “Override function”.
The timer is started and the running time is 8 hours.
De-activate the “Override function” to stop and reset the timer.

Settings:
Set the current speed

Status:
Status of current fan pressure*
Status start relay
* = Only if configured

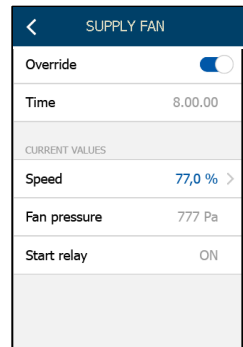



18.2 Commissioning the heat recovery

Heat recovery status/readouts:

Settings:
Override On/Off

Status:
Current heat recovery
Current 0–10V output heat recovery
Current supply air temperature

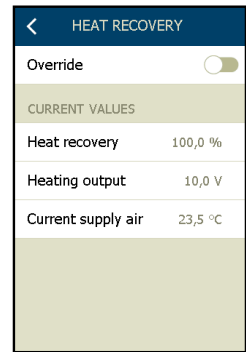

Heat recovery override:

Activate the “Override function” by pushing the switch to the right. Timer is started and the running time is 8 hours. De-activate the “Override function” by pushing the switch to the left to stop and reset the timer.

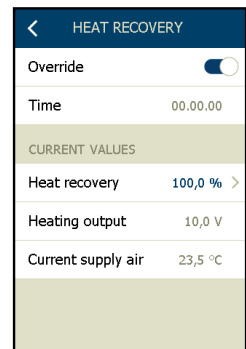

Settings:
Current recovery % open - Save override settings with ”OK”.

Status:
Current 0-10V heating output
Current supply air temp. (°C/°F)

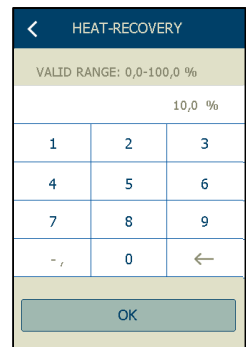



18.3 Commissioning the heater

Heater status/readouts:

Settings:

Override On/Off

Status:

Current heating %

Current 0-10V output, heating coil

Current status of the heating relay (1*)

Current status of the heating relay 2*

Current supply air temp. (°C/°F)

Current return water temperature**

*= Only electric heater

**=Only water heating and only if sensor configured

Heater override:

Activate the “Override function” by pushing the switch to the right.

This starts the timer and the running time is 8 hours.

De-activate the “Override function” by pushing the switch to the left to stop and reset the timer.

Settings:

Current heating % open - Save override settings with ”OK”.

Status:

Current 0-10V heating output

Current status of the heating relay

Current supply air temp. (°C/°F)

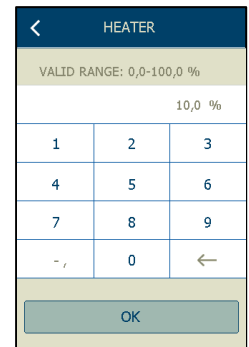
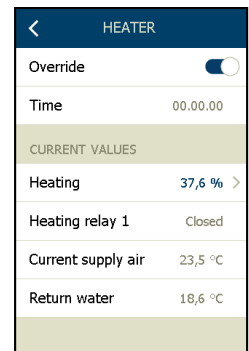
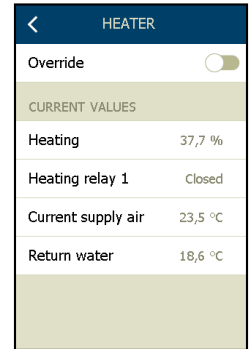



18.4 Commissioning the cooler

Cooler status/readouts:

Settings:
Override On/Off

Status:
Current cooling %
Current 0-10V output cooling coil
Current status on the cooling relay 1
Current supply air temp. (°C/°F)

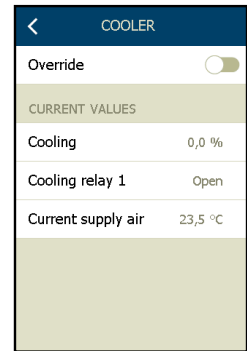

Cooler override:

Activate the “Override function” by pushing the switch to the right. This starts the timer and the running time is 8 hours.
De-activate the “Override function” by pushing the switch to the left to stop and reset the timer.

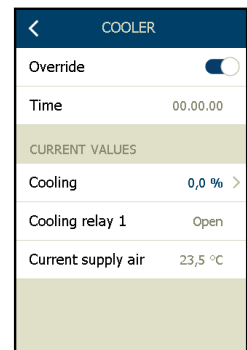

Settings:
Set cooling % override - Save override settings with ”OK”.

Status:
Current 0-10V cooling output
Status of cooling relays 1
Current supply air temperature

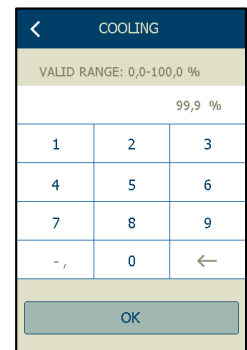



18.5 Commissioning the temperature sensors

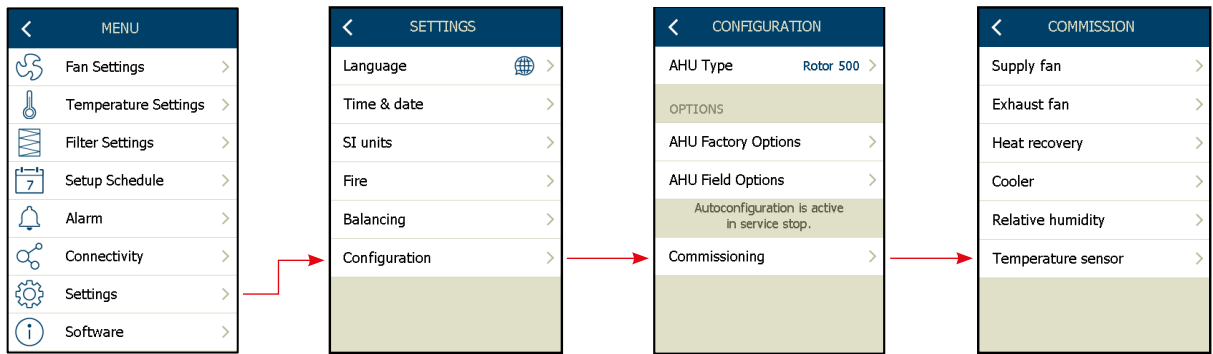

Temperature sensors

- Read out all connected temperature sensors.
- Set the sensor correction (-3.5°C to +3.5°C)

Sensor correction is an option for adjusting the temperature displayed on the sensor in the AHC-3000 system so that it will show the same value as the temperature measured by an external thermometer.

Scroll “Down” for more temperature sensors.

TEMP. SENSORS	
Outdoor air	20,0 °C
Sensor correction	-1,6 °C >
Supply air	26,0 °C
Sensor correction	1,6 °C >
▼	
Extract air	24,0 °C
Sensor correction	1,6 °C >
Exhaust air	23,0 °C
Sensor correction	1,6 °C >
▼	
Return water temp.	18,6 °C
Sensor correction	0,0 °C >
Room temperature	25,1 °C
Sensor correction	0,0 °C >



18.6 Commissioning the CO2 sensors

CO2 sensors

- Read out the current value on the connected CO2 sensor.
- Current input on the 0-10V analogue input

The screenshot shows a mobile application interface with a dark blue header containing a back arrow and the text 'CO2 SENSOR'. Below the header is a table with two rows: 'VOC/CO2' with a value of '777 ppm' and 'Current input' with a value of '10,0 V'. The bottom half of the screen is a large, empty, light beige rectangular area.

CO2 SENSOR	
VOC/CO2	777 ppm
Current input	10,0 V

18.7 Commissioning the humidity sensors

Extract-air humidity sensor

- Read out the current value on the connected humidity sensor (*HTH-6202 Modbus sensor*)
 - Current extract-air humidity

The screenshot shows a mobile application interface with a dark blue header containing a back arrow and the text 'RELATIVE HUMIDITY'. Below the header is a table with two rows: 'Humidity' with a value of '777 %RH' and 'Current input' with a value of '10,0 V'. The bottom half of the screen is a large, empty, light beige rectangular area.

RELATIVE HUMIDITY	
Humidity	777 %RH
Current input	10,0 V



19. Control settings

19.1 Fan control mode: Constant pressure

- Select the fan control mode: Constant pressure
– the procedure is the same for the supply* and exhaust air fans.

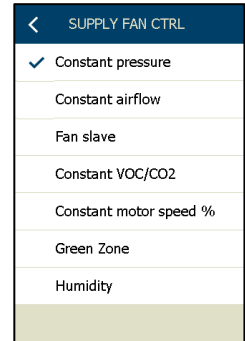
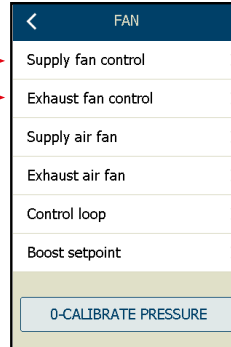
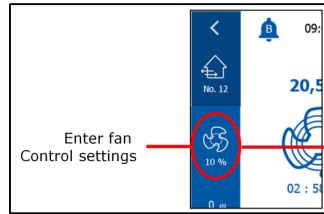

- * Under Supply fan control, it is only possible to select this control modes:
 - * Constant pressure
 - * Constant airflow
 - * Fan slave
 - * Constant motor speed
 - * Green Zone

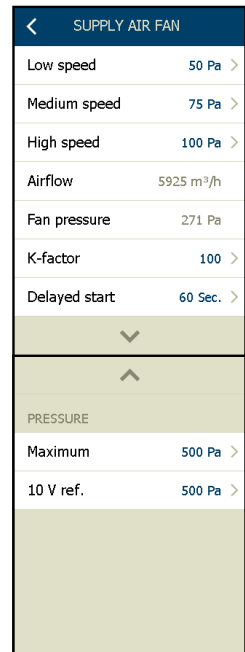
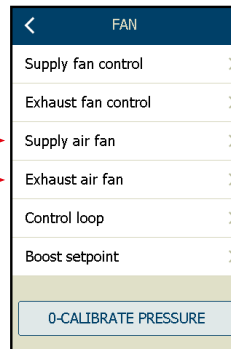

- Set the control parameters for the selected control mode
 - ✓ **Low speed** (Pressure setpoint)
 - ✓ **Medium speed** (Pressure setpoint)
 - ✓ **High speed** (Pressure setpoint)
 - ✓ **Air flow** (current value)***
 - ✓ **Fan pressure** (current value)***
 - ✓ **Supply air duct** (current value)
 - ✓ **Energy consumption** (current value, only OJ-DV)
 - ✓ **K-factor** (l/s)***
 - ✓ **Delayed start** (time setpoint)
 - ✓ **Maximum** (maximum scale pressure)**
 - ✓ **10 V ref.** (10 V on the measure input)**

**=Only duct pressure
***=Only if flow is measured/configured

19.1.1 K-factor explanation

The k-factor must be entered in l/s (liter per second).
If your fan manufacturer listed the k-factor in m³/h, you will need to divide by 3.6 before entering the value into AHC-3000. (see sample)

Sample:

If your fan manufacturer listed the actual fan k-factor to 381 m³/h, the k-factor that you enter the AHC-3000 must be divided by 3.6. That why the k-factor, in this sample, must be entered in the AHC-3000 system with the value = 106.

Flow calculation example

$$\Delta P = 700\text{Pa} \quad k = 381$$

$$q_v = k \cdot \sqrt{\Delta p} = 381 \cdot \sqrt{700} = 10080 \text{ m}^3/\text{h}$$

Conversion from m³/h to l/s :

$$q_v = k \cdot \sqrt{\Delta p} = \frac{381}{3.6} \sqrt{700} = 106 \sqrt{700} = 2804 \text{ l/s}$$

Set k-factor to 106

Conversion from l/s to m³/h:

$$q_v = k \cdot \sqrt{\Delta p} = 106 \cdot 3.6 \sqrt{700} = 381 \sqrt{700} = 10080 \text{ m}^3/\text{h}$$

Set k-factor to 381

BR956C12a



19.2 Fan control mode: Constant air flow

- Select the fan control mode: Constant air flow
 – the procedure is the same for the supply and exhaust air fans.

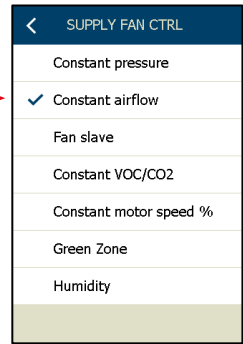
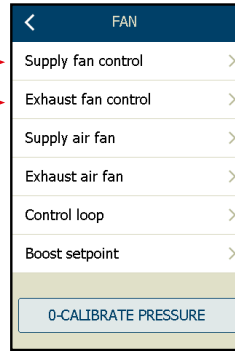
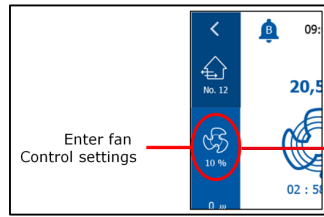

- * Under Supply fan control, it is only possible to select this control modes:
 - * Constant pressure
 - * Constant airflow
 - * Fan slave
 - * Constant motor speed
 - * Green Zone

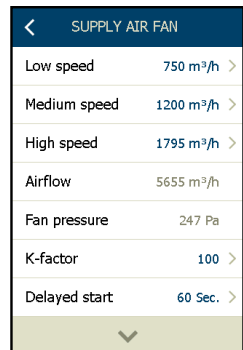
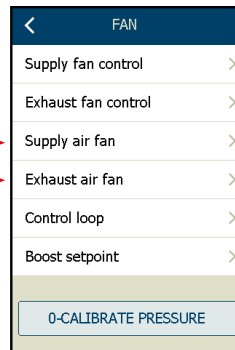

- Set the control parameters for the selected control mode

- ✓ **Low speed** (flow setpoint)
- ✓ **Medium speed** (flow setpoint)
- ✓ **High speed** (flow setpoint)
- ✓ **Airflow** (flow current value)
- ✓ **Fan pressure** (current value)
- ✓ **Energy consumption** (current value, only OJ-DV)
- ✓ **K-factor** (l/s)
- ✓ **Delayed start** (setpoint)

Setpoints can be changed by touching the blue setpoint values and changing the value via the setpoint keyboard. Save & exit with “OK”

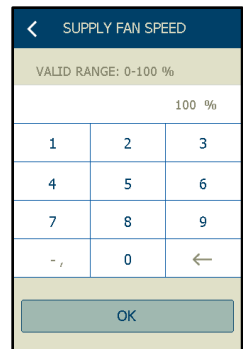



19.3 Fan control mode: Exhaust air slave

Exhaust slave requires measuring the flow of both the supply and exhaust air, for perfect balanced ventilaton.

If no flow measurement, the current fan speed will be used, as offset setpoint, instead.

It is not possible to select the supply air slave and exhaust air slave together.

Select the fan control mode: Exhaust air slave

– the procedure is the same for the supply and extract air fans.

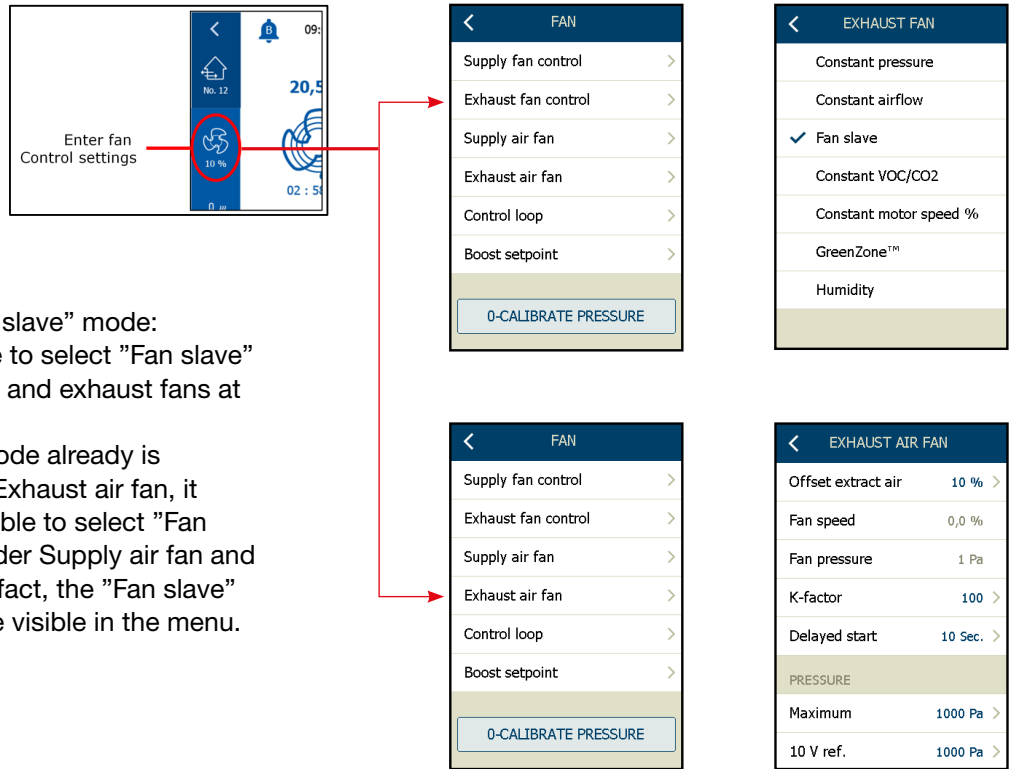

Special on "Fan slave" mode:

It is not possible to select "Fan slave" mode on supply and exhaust fans at the same time.

If "Fan slave" mode already is selected under Exhaust air fan, it will not be possible to select "Fan slave" mode under Supply air fan and because of this fact, the "Fan slave" mode will not be visible in the menu.

- ✓ **Offset extract air*** (+/-% according to the supply air)
- ✓ **Fan speed** (current fan speed)
- ✓ **Fan pressure****
- ✓ **K-factor**** (l/s)
- ✓ **Energy consumption** (current value, only OJ-DV)
- ✓ **Delayed start** (time setpoint)

*=If flow measurement is configured, the value is %-offset according to the actual flow.

If no flow measurement is configured, the value is %-offset according to the actual fan speed.

**=Only if flow is measured/configured

Setpoints can be changed by touching the blue setpoint values and changing values via the setpoint keyboard. Save & exit with "OK"

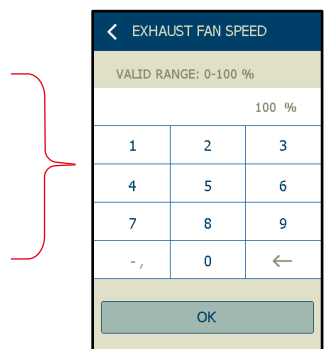



19.4 Fan control mode: Supply air slave

Supply air slave requires measuring the flow of both the supply and exhaust air, for perfect balanced ventilaton.

If no flow measurement, the current fan speed will be used, as offset setpoint, instead.

It is not possible to select supply air slave and exhaust air slave together.

- Select the fan control mode: Extract air slave
 – the procedure is the same for supply and extract air fans.

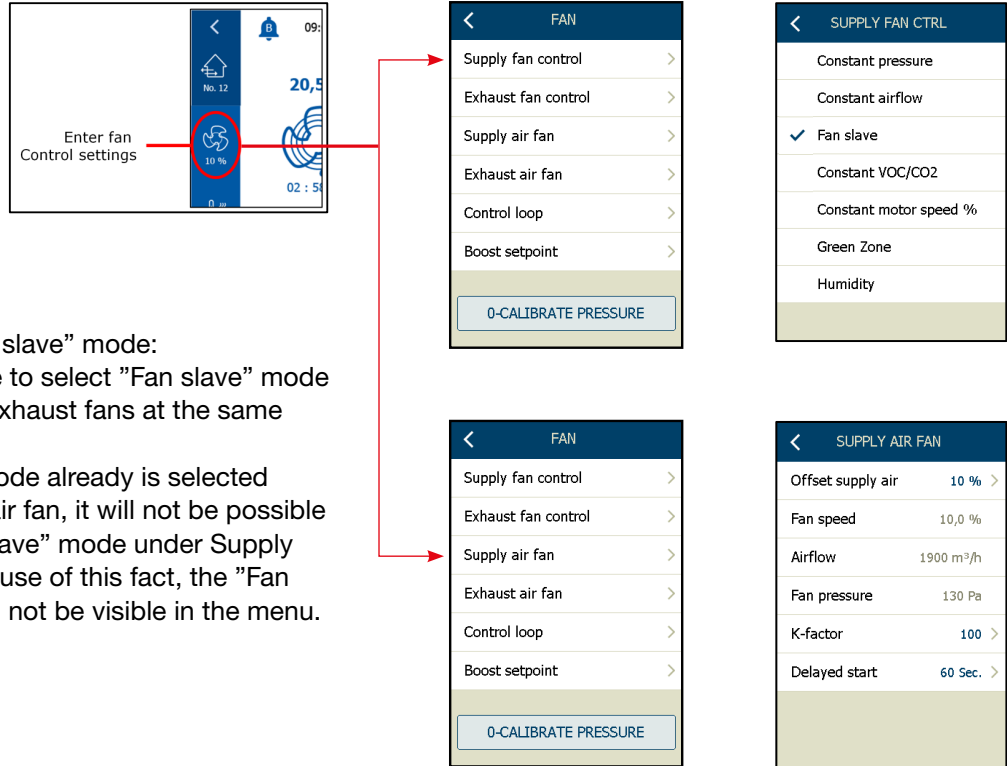

Special on "Fan slave" mode:
 It is not possible to select "Fan slave" mode on supply and exhaust fans at the same time.
 If "Fan slave" mode already is selected under Exhaust air fan, it will not be possible to select "Fan slave" mode under Supply air fan and because of this fact, the "Fan slave" mode will not be visible in the menu.

- ✓ **Offset supply air*** (+/-% according to the supply air fan)
- ✓ **Fan speed** (current fan speed)
- ✓ **Airflow****
- ✓ **Fan pressure**** (current fan pressure, only displayed if the pressure is measured)
- ✓ **K-factor**** (l/s)
- ✓ **Energy consumption** (current value, only OJ-DV)
- ✓ **Delayed start** (time setpoint)

*=If flow measurement is configured, the value is %-offset according to the actual flow.
 If no flow measurement is configured, the value is %-offset according to the actual fan speed.
 **=Only if flow is measured/configured

Setpoints can be changed by touching the blue setpoint values and changing values via the setpoint keyboard. Save & exit with "OK"

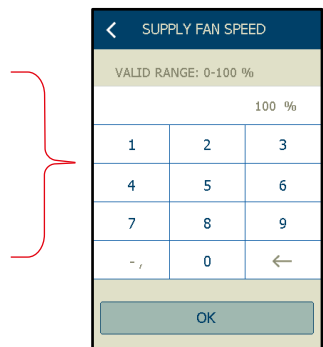



19.5 Fan control mode: Constant VOC/CO2

To control the AHU according to the VOC/CO2 in the room/extract air duct, requires a VOC sensor (VTH-6202) or a CO2 sensor (0-10V) placed either in the room or in the extract duct/-air flow.

If the VOC/CO2 is detected during the “Autoconfiguration”, it will be possible to select the mode “Constant VOC/CO2” under the menu “Exhaust fan control”. The speed of the exhaust air fan will be controlled according to the setpoint (ppm) within a selectable limitation on min. and max. air flow*, in the exhaust air.

To prevent over/under pressure in the room, the control of the supply air fan, will normally from the factory or installer be selected to “Fan slave”, so that the supply air fan will follow the exhaust air fan. It will also be possible to select an offset in the slave fan, if necessary.

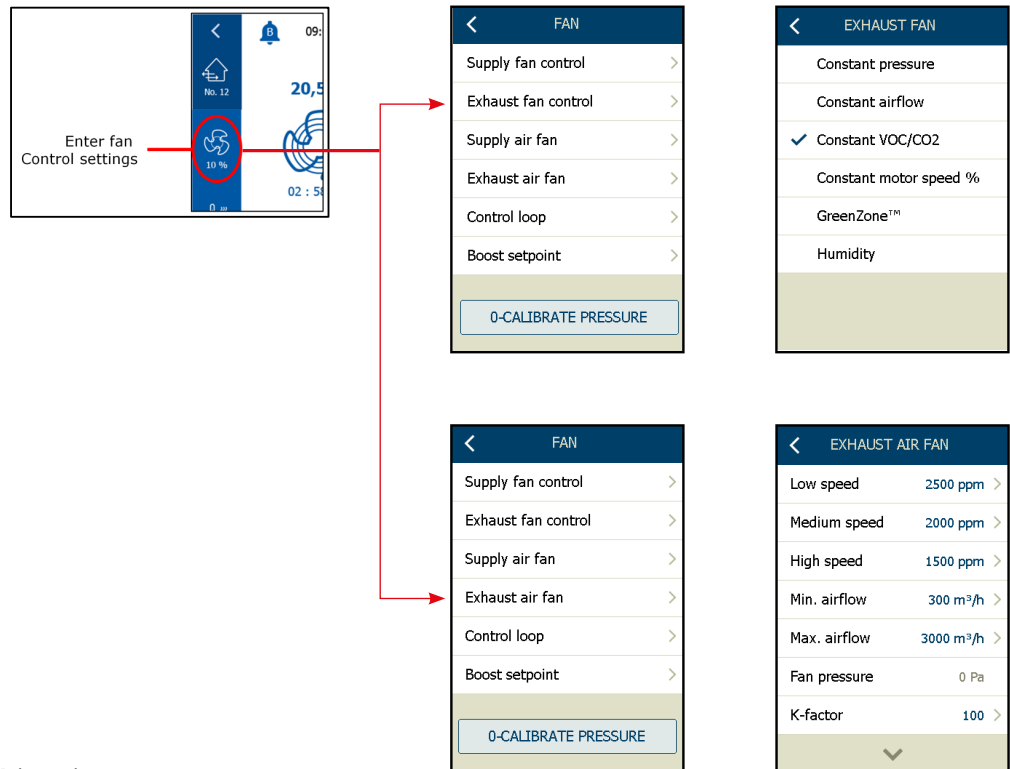

- Setpoints
 - ✓ **Low speed** (ppm)
 - ✓ **Medium speed** (ppm)
 - ✓ **High speed** (ppm)
 - ✓ **Min. airflow** (m³/h)
 - – if the current ppm is lower than setpoint ppm, the fan speed will reduce to min air flow*.
 - ✓ **Max. airflow** (m³/h)
 - – if the current ppm is lower than setpoint ppm, the fan speed will increase to max air flow*.
 - ✓ **Fan pressure – actual fan pressure** (only if measured)
 - ✓ **K-factor – informed from the fan manufacturer** (must be in l/s)



Note

*=If no flow measurement is installed and configured, the setpoints for min. and **max. air flow** will be displayed in % fan speed.

Supply air fan control: See index 19.4



19.6 Fan control mode: Constant motor speed %

- Select the fan control mode: Constant motor speed
 - procedure is the same for supply and extract air fan.
 - in this sample, only supply air fan is shown.

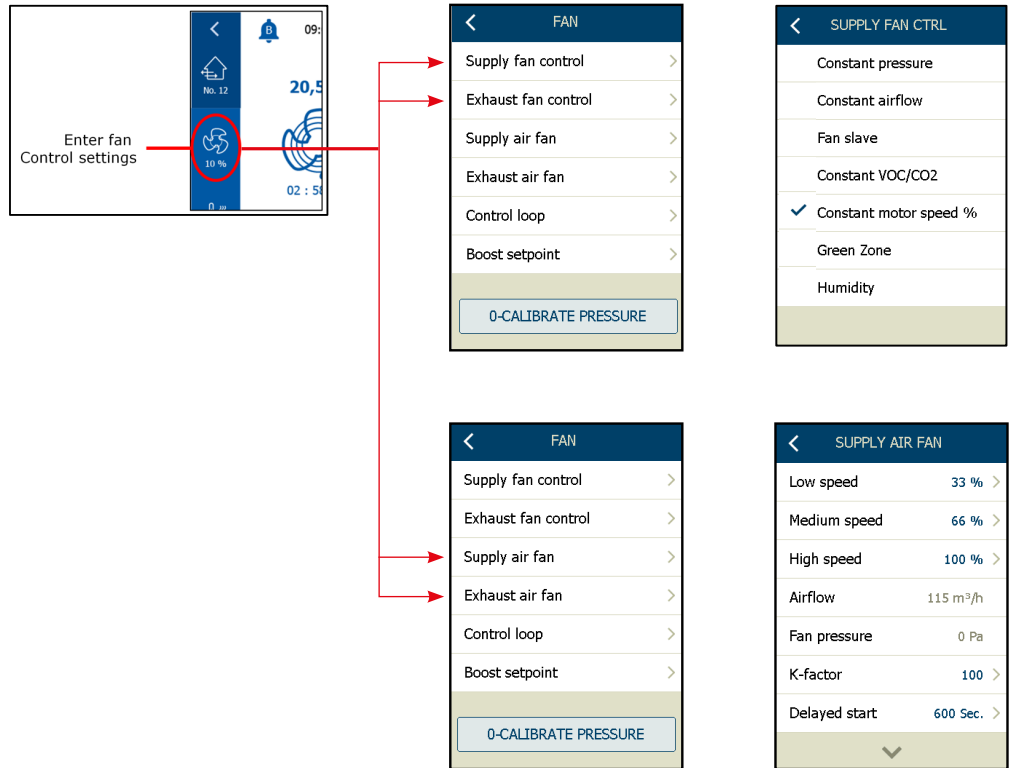

- ✓ **Low speed** (setpoint)
 - ✓ **Medium speed** (setpoint)
 - ✓ **High speed** (setpoint)
 - ✓ **Airflow*** (current value)
 - ✓ **Fan pressure*** (current value)
 - ✓ **Supply air duct*** (current value)
 - ✓ **Energy consumption** (current value, only OJ-DV)
 - ✓ **K-factor*** (l/s)
 - ✓ **Delayed start** (setpoint)
- *= only when flow measuring is configured

Setpoints can be changed by touching the blue setpoint values and changing the values via the setpoint keyboard. Save & exit with "OK"

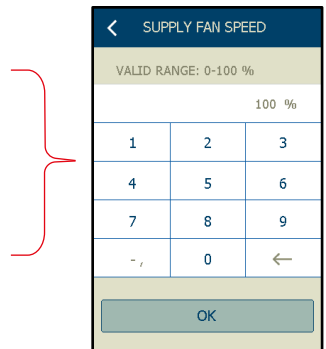



19.7 Air-control loop settings

- If the airflow oscillates, it may be necessary to change the parameter settings in the fan-speed control loop.
- The available parameters are the P-band and the I-time.
- If the airflow/pressure oscillates, it helps to increase the P-band and the I-time
- Normally these parameters are OK from the factory.

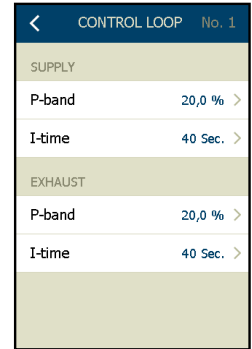
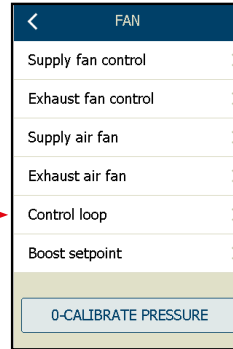
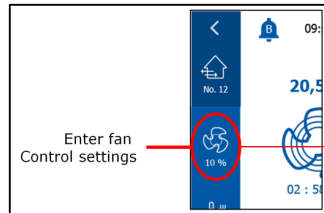

Note

Parameter for P-band and I-time is not displayed, if the control loop is selected to "Constant fan speed" or "Green Zone".

19.8 Boost setpoint

- If "Boost start" is activated via the digital input boost speed, the HMI-35T hand terminal or the HMI-20T room panel display, the AHU will go into "Boost speed".
- On this menu, you select the speed that the AHU will take in boost mode.
- The boost mode is active until the timer in the HMI-35T hand-held terminal or the HMI-20T room panel display runs out of time – or the digital input boost speed, is opened.

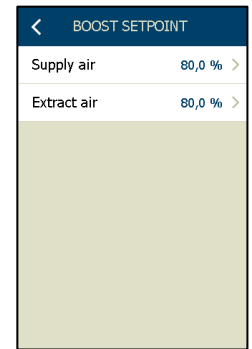
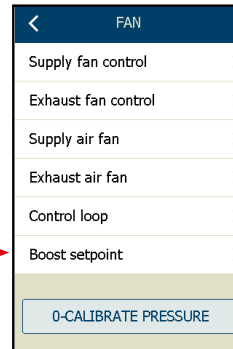
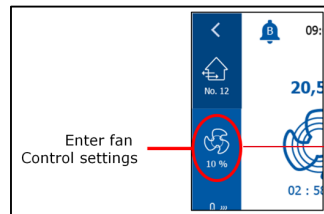

- Supply air
 - ✓ Select the boost setpoint in % of the speed on the supply air fan
- Extract air
 - ✓ Select the boost setpoint in % of the speed on the exhaust air fan



19.9 Zero-calibrating the pressure transmitters

To eliminate the deviation of zero point measurement when the pressure transmitters are without pressure, it is possible here to start the procedure for the 0-calibration of all the system pressure transmitters.

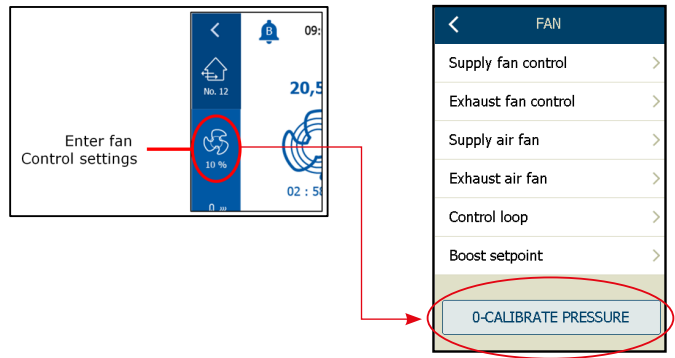

All installed modbus pressure transmitters in the configuration will be zero calibrated.

Zero calibration will be made automatic at each stop or manually via the “**0-CALIBRATE PRESSURE**” button.

Auto 0-calibration

The 0-calibration will be made every time the AHU is in “Stop”. Either the stop signal is made manually from the user interface (HMI-35-T) or the AHU is stopped via a signal from the time scheduler. When the AHU is stopped and the pressure transmitters do not measure any turbulence in the pressure tubes, the 0-calibration will start.

Manual 0-calibration

Press “**0-CALIBRATE PRESSURE**” to start the 0-calibration.



Note

The 0-Calibration button will only be displayed, if pressure transmitters (PTH-6202 or PTH-6202-2) was detected, during the autoconfiguration process - see index 16. If no pressure transmitter are detected in the configuration, the 0-Calibration button will not be displayed.



Note

- A automatic 0-calibration of all pressure transmitters, will be automatic made after every stop.
- Only when the AHU is in operation mode “Stop”, it will be possible by manual to start a 0-calibration process. The 0-calibration process, will last approx. 10 sec.
- The 0-calibration button will only be visible, when the AHU is in operation mode “Stop”..

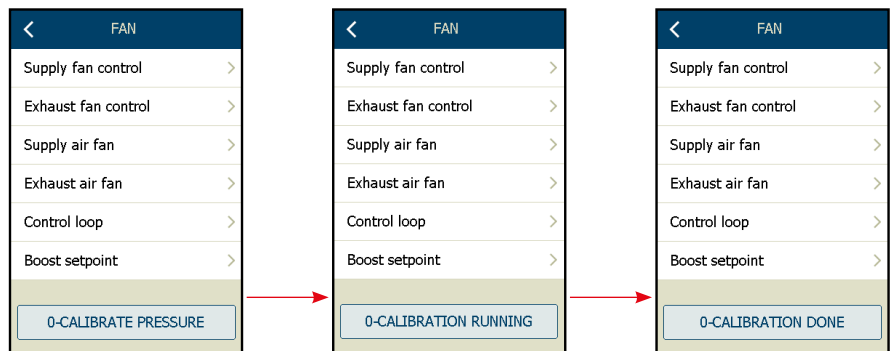



20. Temperature control settings

The temperature control mode is selected here:

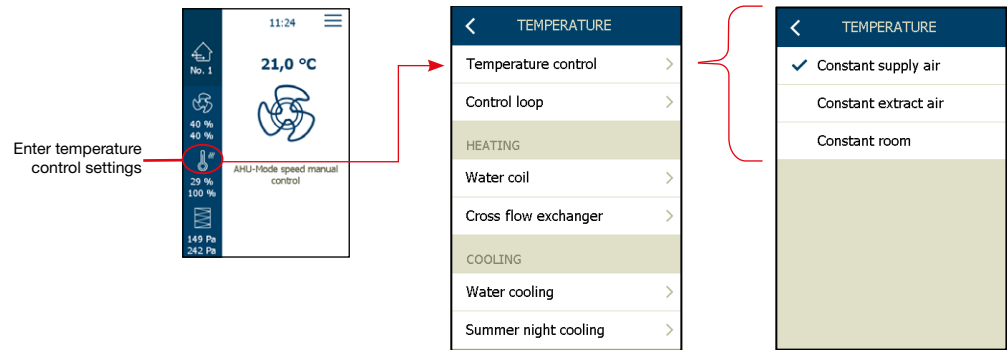

- Constant supply air
 - Temperature is controlled in relation to the supply-air temperature measured by the supply air sensor located in the supply air duct.
 - The required supply air temperature setpoint is set from the HMI main screen display.
- Constant extract air
 - Temperature is controlled in relation to extract air temperature measured by the extract air sensor located in the extract air duct.
 - The required extract air temperature setpoint is set from the HMI main screen display.
- Constant room
 - Temperature is controlled in relation to room-air temperature measured by the room sensor located in the room.
 - The required room temperature setpoint is set from the HMI-20T room panel or the HMI main screen display.



Note

To change the temperature control mode, the AHU must be in “Service stop”



20.1 Temperature control loop settings

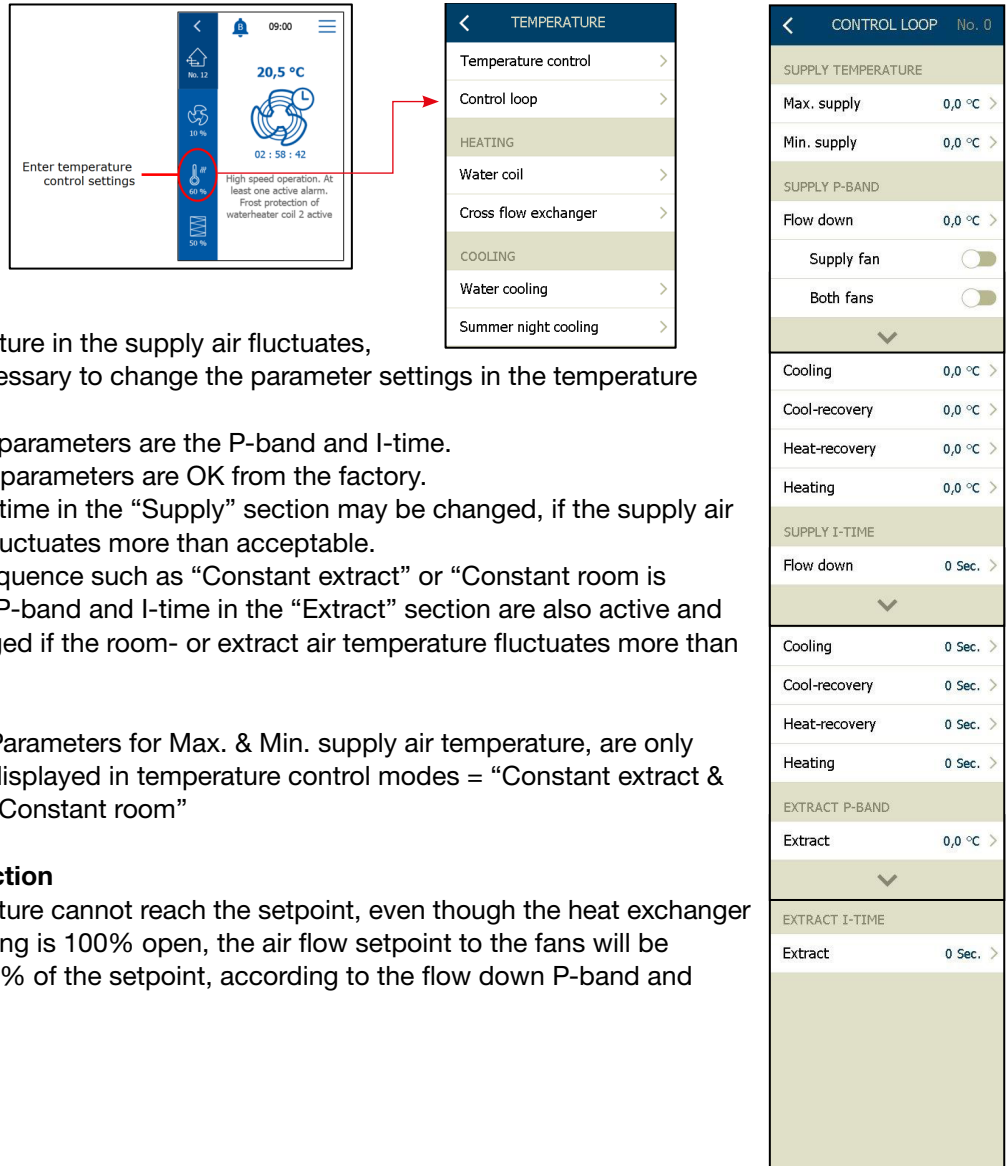

- If the temperature in the supply air fluctuates, it may be necessary to change the parameter settings in the temperature control loop.
- The available parameters are the P-band and I-time.
- Normal these parameters are OK from the factory.
- P-band and I-time in the “Supply” section may be changed, if the supply air temperature fluctuates more than acceptable.
- If a control sequence such as “Constant extract” or “Constant room is selected, the P-band and I-time in the “Extract” section are also active and may be changed if the room- or extract air temperature fluctuates more than is acceptable.



Note Parameters for Max. & Min. supply air temperature, are only displayed in temperature control modes = “Constant extract & “Constant room”

Flow down function

- If the temperature cannot reach the setpoint, even though the heat exchanger AND the heating is 100% open, the air flow setpoint to the fans will be reduced to 50% of the setpoint, according to the flow down P-band and I-time.

- Flow down selection

Comment	Supply fan	Both fans	Flow down
Factory setting	On	On	Both fans
	On	Off	Only supply fan
	Off	Off	No fans
	Off*	On*	Both fans*

*Not selectable. If both fans are on, the supply fan is automatically set to on within 5 seconds



Note New software version (2.00 or later) Flow down is still ignored when the flow down P-Band is set to value 0°C.

Cool recovery function

- The cool recovery function will be activated, when/if there is a cooling demand AND the outdoor temperature is >1,0°C above the extract air/room temperature.
- The cool recovery function will be de-activated, when/if there is no cooling demand OR the outdoor temperature is <0,5°C above the extract air/room temperature.

Basics on the temperature control sequence:

The difference between the temperature setpoint and the current value on the temperature sensor = Output will take half of the difference on the P-band as a "here-and-now-reaction". The velocity of the second half of the P-band will be cut in or cut out using the I-time. The calculation and recalculation of the fault are on-going calculations.

P-band and I-time influence

Higher P-band and I-time will give a slower reaction on the output and a slower reaction on the output will probably leave a more stable temperature control. Not all oscillations can be solved by changing the P-band and I-time.

P-band and I-time cannot save the world

For instance: In a water based heating system, the differential pressure over the valve is important to the temperature control stability. If the differential pressure over the valve is very high (more than 0,1 Bar or 1,0 mH2O) it may not be possible to create a stable temperature control, adjusting the P-band and/or the I-time. You must lower the differential pressure over the valve.

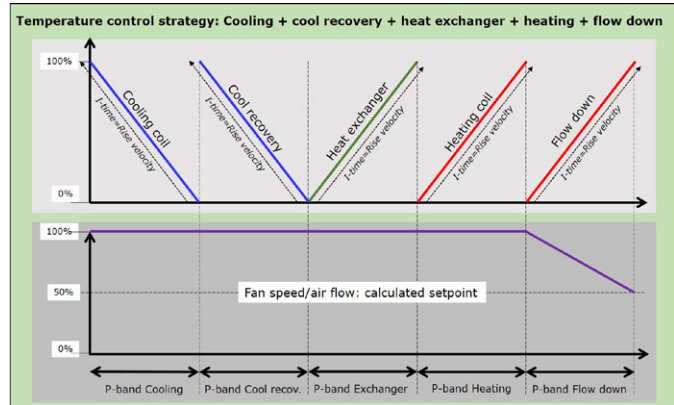

20.2 Heating coil settings (Water coil)

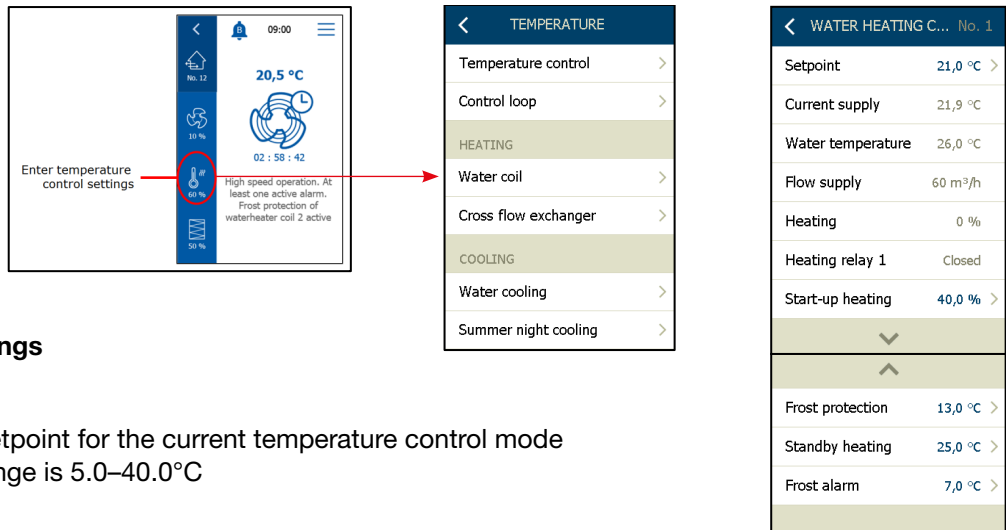

Available settings

Setpoint

- ✓ Current setpoint for the current temperature control mode
- ✓ Setting range is 5.0–40.0°C

Current Supply

- ✓ Current supply air temperature

Water temperature* (*Only if water temperature sensor is configured)

- ✓ Current temperature from water heating coil, measured by the return pipe sensor.

Flow supply

- ✓ Current supply air flow (m³/h)* (*Only if flow measuring is installed and configured)

Heating

- ✓ Current status value on the heating valve output (Range 0-100%)



Heating relay 1

- √ Current status on the digital relay output for the circulation pump.
NOTE: The "Heating relay 1" has a after running time of 300 sec.
"Heating relay 1" is constant "On", by outdoor temperatures below +12,0°C

Start-up heating

- √ During the start-up sequence of the AHU, the heating valve will be overridden to the selected value. The override of the heating valve stops when the start-up sequence is completed and the inlet fan has reached 50% of the set point of air volume/pressure/speed.

Frost protection

- √ During normal operation of the AHU, the return pipe sensor on the heating coil will ensure that the return temperature from the water coil, does not get below the set value in this parameter.
- √ If the return temperature from the water heating coil is below this "Frost protection" setpoint, the valve will be overridden towards open and the circ. pump start (Heating relay 1 = "On").
- √ Status text on the HMI display will show: "Frost protection of water heating coil 1 active".
- √ The valve will reach 100% open, when the return temperature from the water coil reaches the setpoint in parameter "Frost alarm".
- √ An extra security for frost protecting the water heating coil, is made via the outdoor sensor. If the outdoor temperature reaches values below 12°C, the circ. pump will start.

Standby heating

- √ When the AHU is in stop/stand-by mode, the return sensor on the water heating coil will ensure that the return temperature from the water coil does not get below the set value in this parameter.
- √ If the return sensor on the water heating coil measures values below "standby heating" setpoint, the valve will be overridden towards open and the circ. pump start (Heating relay 1 = "On").

Frost alarm

- √ Setpoint for frost alarm. At temperatures below the setpoint, the AHU will stop, the pump will start, the heating valve will be overridden to 100% open and an "A" alarm will be triggered.



20.3 Heating coil settings (Electric coil 1)

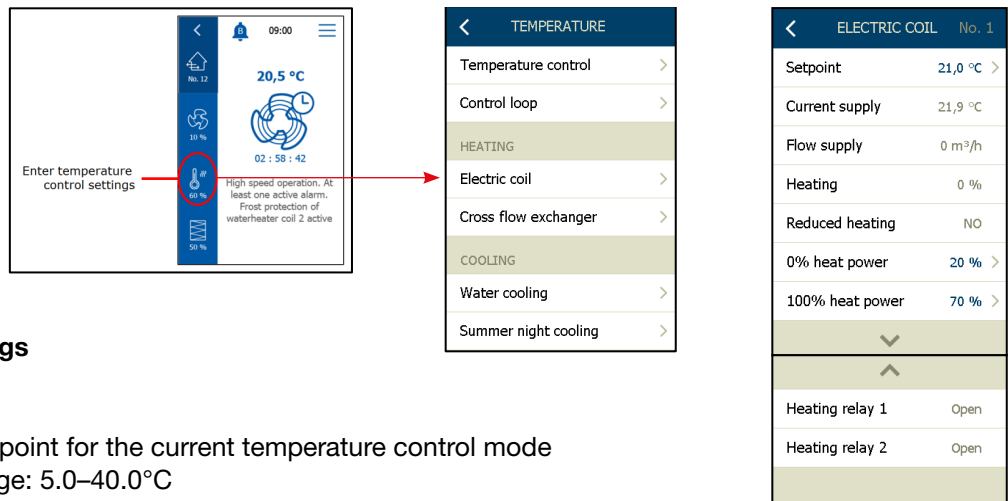

Available settings

Setpoint

- ✓ Current setpoint for the current temperature control mode
- ✓ Setting range: 5.0–40.0°C

Current

- ✓ Current supply air temperature

Flow supply

- ✓ Current supply air flow (m³/h)

Heating

- ✓ Current status value on the heating analog output (range 0–100%)

Reduced heating

- ✓ Current status on the reduced heating function.
- ✓ “YES”: If the heating has been because the supply air flow is lower than the set value
- ✓ “NO”: If the heating is not reduced

0% heat power*

- o If the supply air volume (m³/h) or supply air fan speed (%) is below value in this setpoint, the power to the electrical heating coil is forced to off.

100% heat power*

- o If the supply air volume (m³/h) or supply air fan speed (%) is below value in this setpoint, the maximum power to the electrical heating coil will be reduced.

*=If no flow measuring is installed, the values will be displayed in % fan speed. If flow measuring is installed, the values will be in % of the max. air flow (AHU size).

Heating relay 1

- ✓ Current status on the heating relay 1
- ✓ Heating relay 1 will close, when the analog output "Heating" is 0,1V

Heating relay 2

- ✓ Current status on the heating relay 2.
- ✓ Heating relay 2 will close, when the analog output "Heating" is 5,0V

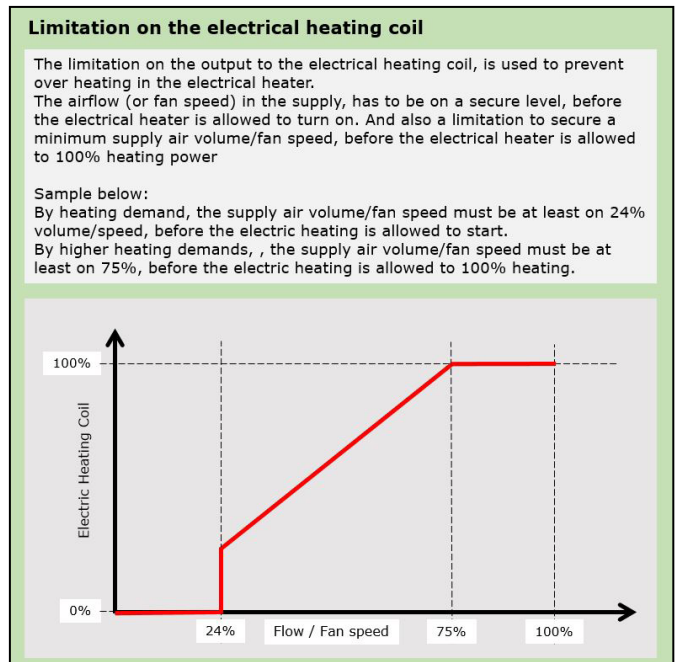



20.4 Combi settings (Water Combi coil, heat pump) heating

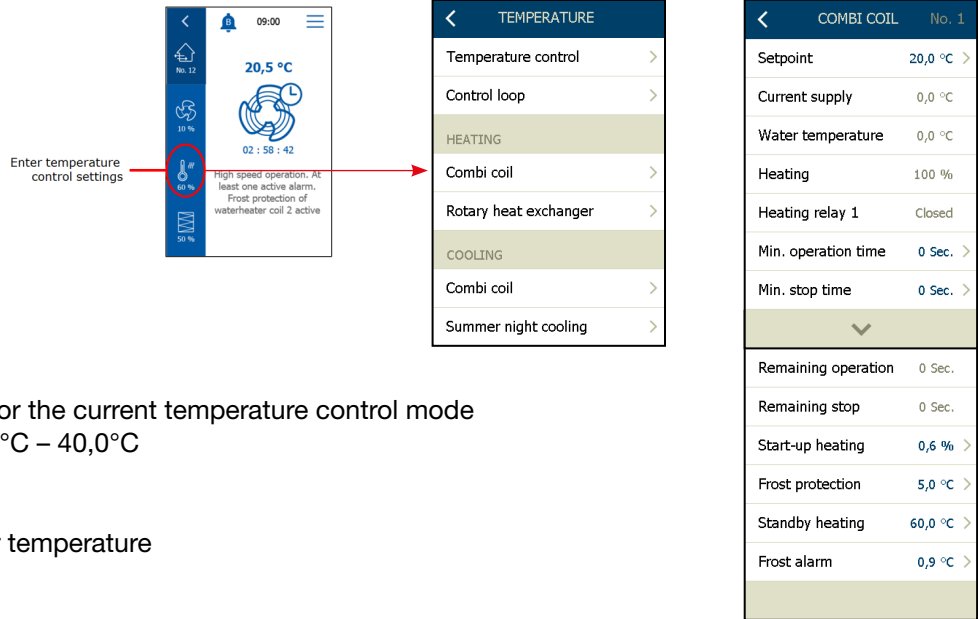

Available settings

Setpoint

- ✓ Current setpoint for the current temperature control mode
- ✓ Setting range: 5,0°C – 40,0°C

Current supply

- ✓ Current supply air temperature

Water temperature

- ✓ Current temperature from water combi coil*, measured by the return pipe sensor.

*=Only if return sensor is configured

Heating

- ✓ Current status value on the heating valve output (Range 0-100%)

Heating relay (Coil 1)

- ✓ Current status (Open/closed) on the digital relay output for the pump in the heating circuit. (Coil 1)

Start-up heating

- ✓ During the start-up sequence of the AHU, the heating valve will override the selected value. The override of the heating valve stops when the start-up sequence is completed, and the supply fan has reached 50% of the setpoint.

Min. operation time

- ✓ When heating is requested, and the heat pump is started then the heating start relay (coil 1) shall stay closed during the “Min. operation time”, no matter how the supply temperature changes.
- ✓ The combi coil 0-10V output signal shall currently be adjusted according to the heating demand during the “Min. operation time”
- ✓ If the temperature becomes OK, then the heating unit will stop after the “Min operation time”
- ✓ Setting range: 0 sec. – 1200 sec.

Min. stop time

- ✓ When heating has been stopped the heating start relay shall stay open during the “Min. stop time”, no matter how the supply temperature changes.
- ✓ The combi coil 0-10V output signal shall currently be adjusted according to the heating demand during the “Min. stop time”.
- ✓ If heating is requested, then the heat pump unit shall start after the “Min. stop time”.
- ✓ Setting range: 0 sec. – 1200 sec.

Remaining operation

- ✓ Remaining time in the current operation

Remaining stop

- ✓ Remaining time before next operation



Frost protection

- ✓ During normal operation of the AHU, the return pipe sensor on the heating coil will ensure that the return flow temperature from the water coil, does not get below the set value in this parameter. If the return temperature from the water coil are below this "Frost protection" setpoint, the valve will be overridden towards open. Status text on the HMI display will show: "Frost protection of water heating coil 1 active". The valve will be overridden to 100% open, when the return temperature from the water combi coil reaches the setpoint in parameter "Frost alarm".

Standby heating

- ✓ When the AHU is in stop/stand-by mode, the return sensor on the water combi coil will ensure that the return flow from the water coil does not get below the set value in this parameter.

Frost alarm

- ✓ Setpoint for frost alarm. By temperatures below setpoint, the AHU will stop, the pump will start, the heating valve will be overridden to 100% open and an "A" alarm will be released.

20.5 Combi coil settings (Water Combi coil, heat pump) cooling

Available settings

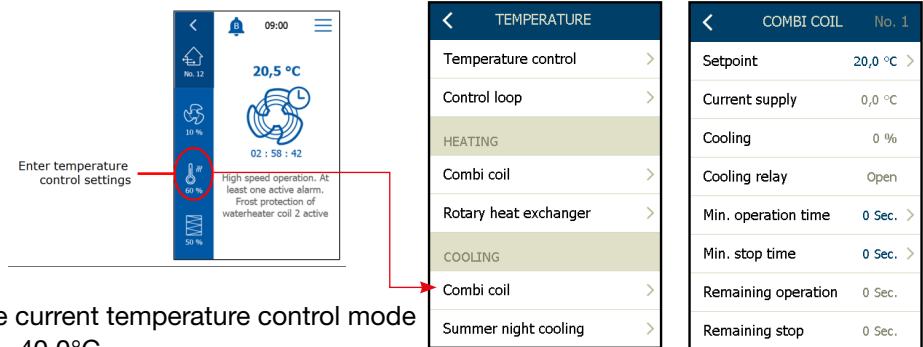

Setpoint

- ✓ Current setpoint for the current temperature control mode
- ✓ Setting range is 5,0°C – 40,0°C

Current supply

- ✓ Current supply air temperature

Cooling

- ✓ Current status value on the cooling valve output (Range 0-100%)

Cooling relay (Coil 2)

- ✓ Current status (Open/closed) on the digital relay output for the pump in the cooling circuit

Min. operation time

- ✓ When cooling is requested, and the heat pump is started the cooling start relay shall stay closed during the "Min. operation time", no matter how the supply temperature changes
- ✓ The combi coil 0-10V output signal shall currently be adjusted according to the cooling demand during the "Min. operation time"
- ✓ If the temperature becomes OK then the heat pump unit will stop after the "Min operation time"
- ✓ Setting range: 0 sec. – 1200 sec.

Min. stop time

- ✓ When cooling has been stopped the cooling relay shall stay open during the "Min stop time", no matter how the supply temperature changes
- ✓ The combi coil 0-10V output signal shall currently be adjusted according to the cooling demand during the "Min stop time"
- ✓ If cooling is requested, then the heat pump unit shall start after the "Min stop time"
- ✓ Setting range: 0 sec. – 1200 sec.

Remaining operation

- ✓ Remaining time in the current operation

Remaining stop

- ✓ Remaining time before next operation



20.6 Cooling coil settings (Water cooling coil)

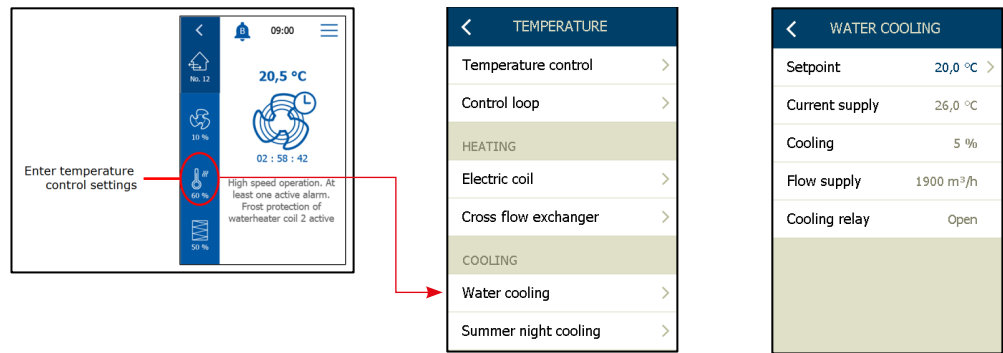

Available settings

Setpoint

- ✓ Current setpoint for the current temperature control mode
- ✓ Setting range: 5.0–40.0°C

Current

- ✓ Current supply-air temperature

Cooling

- ✓ Current status value of the cooling valve (range 0–100%)

Supply air flow**

- ✓ Current supply-air flow (m³/h)

Cooling relay

- ✓ Current status of the cooling relay (Open/Closed)

**=Only if flow is measured/configured



20.7 Cross-flow heat-exchanger settings

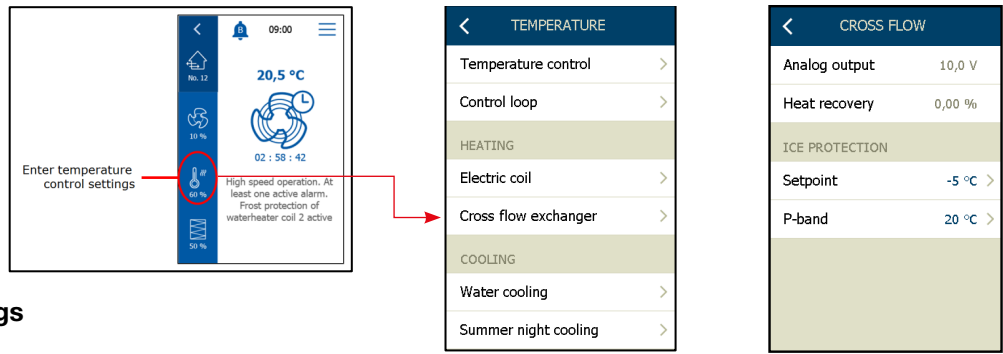

Available settings

Analogue output

- ✓ Current status value on the bypass-damper analogue output

Heat recovery

- ✓ Current heat recovery output



Note

Ice protection of the cross flow heat exchanger, can either be made via the exhaust temperature sensor (Setpoint) or via a pressure transmitter over the heat exchanger

Ice protection via exhaust sensor

Setpoint

- ✓ Current setpoint for the ice protection
- ✓ At exhaust temperatures below set value + P-band, the bypass damper will override modulating to 100% open. Thereby, the outdoor air by-passes the heat exchanger into the supply air and extract air from the room, passes through the heat exchanger. Due to the relatively high room temperature, this function will lead to thawing of the ice coating on the heat exchanger.

P-band

- ✓ Exhaust temperatures below P-band + the setpoint in the parameter, "Ice protection" will override the bypass damper modulating to 100% open.

Ice protection via pressure transmitter

To use iceprotection via pressure transmitter, flow measuring must be configured and PTH-6202#8 must be installed.

Setpoint

- ✓ Current setpoint - %-value the pressure drop over the heat exchanger is allowed before de-frost procedure is executed.

Pressure drop

- ✓ Current pressure drop over the heat exchanger.

Pressure limit

- ✓ Current calculated alarm limit according to "Setpoint %" and the actual flow/fan speed.

Measure

- ✓ To measure out a new heat exchanger: Press "Measure"
- ✓ The fans will stop and re-start, slowly from 0 → 100% and simultaneously recognize the pressure drop characteristics of the clean heat exchanger.
- ✓ De-icing alarm limit is now set in parameter "Setpoint", in percentages of allowed higher value (%), compared to pressure drop on a completely clean and ice-free heat exchanger.

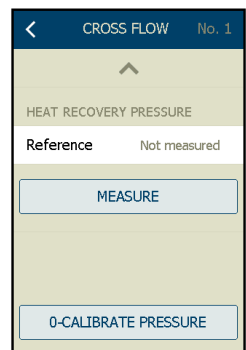
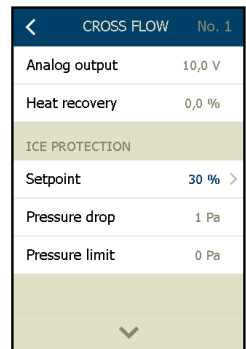



20.8 Counter-flow heat-exchanger settings

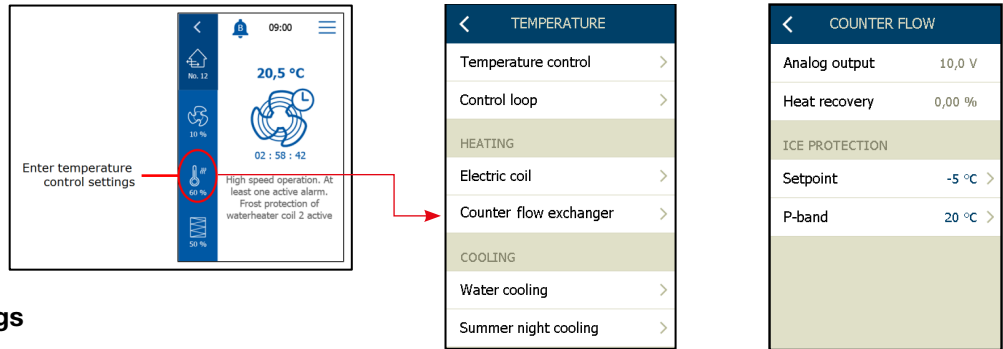

Available settings

Analogue output

- ✓ Current status value on the by-pass damper analogue output

Heat recovery

- ✓ Current heat recovery output



Note

Ice protection of the counter flow heat exchanger, can either be made via the exhaust temperature sensor (Setpoint) or via a pressure transmitter over the counter flow heat exchanger

Ice protection via exhaust sensor

Setpoint

- ✓ Current setpoint for the ice protection
- ✓ At exhaust temperatures below set value + P-band, the bypass damper will override modulating to 100% open. Thereby, the outdoor air by-passes the heat exchanger into the supply air and extract air from the room, passes through the heat exchanger. Due to the relatively high room temperature, this function will lead to thawing of the ice coating on the heat exchanger.

P-band

- ✓ Exhaust temperatures below P-band + the setpoint in the parameter, "Ice protection" will override the bypass damper modulating to 100% open.

Ice protection via pressure transmitter

To use iceprotection via pressure transmitter, flow measuring must be configured and PTH-6202#8 must be installed.

Setpoint

- ✓ Current setpoint - %-value the pressure drop over the heat exchanger is allowed before de-frost procedure is executed.

Pressure drop

- ✓ Current pressure drop over the heat exchanger.

Pressure limit

- ✓ Current calculated alarm limit, with reference to "Setpoint %" and the actual flow/fan speed.

Measure

- ✓ To measure out a new heat exchanger: Press "Measure"
- ✓ The fans will stop and re-start, slowly from 0 → 100% and simultaneously recognize the pressure drop characteristics of the clean heat exchanger.
- ✓ De-icing alarm limit is now set in parameter "Setpoint", in percentages of allowed higher value (%), compared to pressure drop on a completely clean and ice-free heat exchanger.

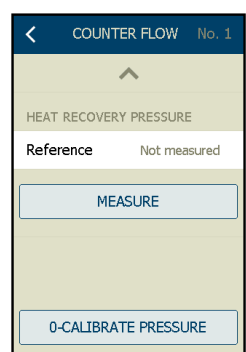
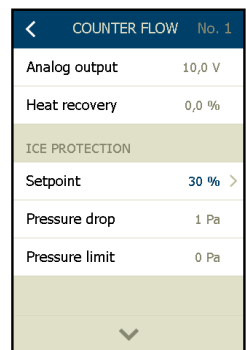



20.9 Rotary heat exchanger settings

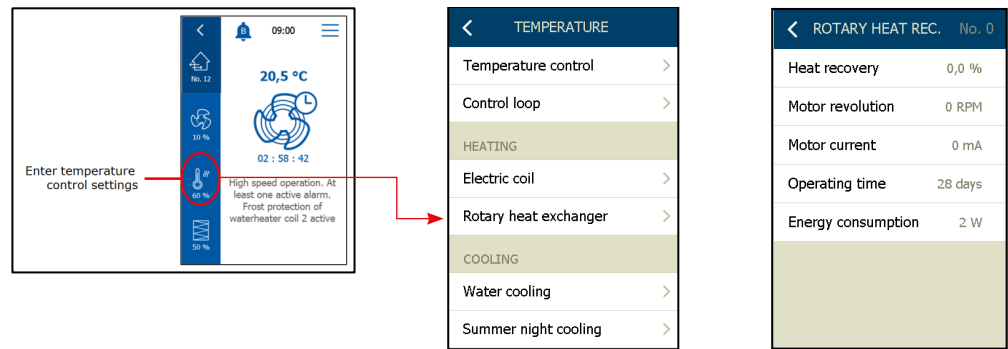

Available settings

Analog output

- ✓ Current value analog output (0-10 VDC) (only in 0-10V control mode)

Heat recovery

- ✓ Current heat recovery setpoint

Motor revolution

- ✓ Current motor speed (rpm) (only DRHX)

Motor current

- ✓ Current motor current (mA) (only DRHX)

Operating time

- ✓ Current operating time (Days) (only DRHX)

Energy consumption

- ✓ (Only DRHX)

Purging function

- The built-in purging function, prevents mechanical breakdown and deformation of the rotor.
- The OJ-DRHX purging function, is controlled from the AHC-3000 control system.
- The purging function starts automatically when the stepper motor has been stopped for 10 minutes.
- The stepper motor will run 10 rotations, at 10% motor speed, after which the stepper motor will stop again.
- During purging, the status text in the HMI-35T is: "Purging the rotary heat exchanger"
- The purging function is repeated every 10 minutes, when the stepper motor is stopped.



20.10 Summer night cooling (Free cooling)

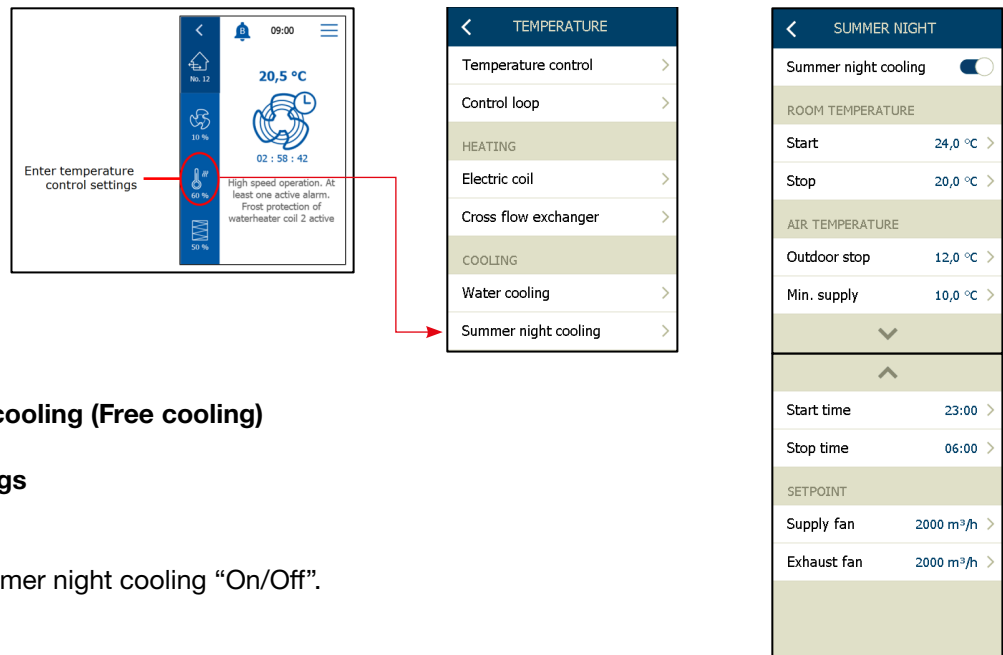

Summer night cooling (Free cooling)

Available settings

Select

- ✓ Select summer night cooling “On/Off”.

Start

- ✓ Summer night cooling starts at a higher room temperature.
- ✓ If no room sensor is installed, the system will start at the start time set under "Start time" in order to measure the current room temperature.
- ✓ The outdoor temperature must be >2°C lower than the measured room/extract temperature.

Stop

- ✓ Summer night cooling stops at lower room temperature/extract temperature.

Outdoor stop

- ✓ Summer night cooling stops (don't start) at a lower outdoor temperature.

Min. supply

- ✓ Minimum supply temperature when summer night cooling is active.
- ✓ The heat exchanger is used to ensure a minimum supply temperature.

Start time

- ✓ Earliest time when summer night cooling starts. Factory setting: 23:00.
- ✓ If the system is not configured with a room sensor but only with an extract sensor, it will start at the set time in order to check room temperature via the extract sensor.
- ✓ If the system is configured with a room sensor, it will continually check the room temperature and begin operating at the set start time.

*=Test temperatures operation: See next page

Stop time

- ✓ Time at which summer night cooling stops. Factory setting: 06:00.

Setpoint supply air fan

- ✓ Enter the setpoint for supply air fan during summer night cooling.

Setpoint exhaust air fan

- ✓ Enter the setpoint for exhaust air fan during summer night cooling.



20.11 Summer night cooling - With or without external outdoor- and room sensor

Sensor locations

The summer night cooling function is available with or without external outdoor- and room temperature sensor configured.

Accepted External outdoor sensor is:

- TTH-6040-O – connected on the Modbus (Port A)

Accepted External Room temperature sensors are:

- 0-10V room sensor connected on the analog input Ain#2
- OJ-Air2-HMI-20T – connected on the Modbus (Port A)
- TTH-6040-W – connected on the Modbus (Port A)

Internal outdoor temperature sensor is:

- PT1000 or NTC12k placed internal the AHU

Internal room temperature sensor => Extract air sensor

- PT1000 or NTC12k placed internal the AHU

Using External sensors

Enable the summer night cooling function via the activation button in the menu.

- If both HTH-6040-O outdoor sensor and a real external room sensor (*from the above accepted room sensor types*) is configured, the summer night cooling function will check the actual temperatures all the time between “Start time” and “Stop time”.
- If all requirements (*described in below bullet #1*) for running summer night cooling is fulfilled, the AHU will start operation in summer night cooling, until one of the requirements (*described in below bullet #2*) is fulfilled.

1. The summer night cooling will start if:

- Actual time is between “Start time” and “Stop time”.
And: Operation mode mode is ”Low speed” or ”Run schedule” Extended stop/Low speed
And: The room temperature is higher than setpoint in parameter “Start” (°C)
And: The outdoor temperature is higher than the parameter “Outdoor stop”.
And: Outdoor temperature is >2°C lower than the room/extract air temperature.
And: There were less than 60 min. heating demand between 12:00 and 23.59, in the last operation period.

2. The Summer night cooling can run multiple start if:

- Actual time is between “Start time” and “Stop time”.
And: Operation mode is ”Low speed” or ”Run schedule” Extended stop/Low speed
And: If external outdoor temperature sensor and room temperature sensor is mounted
And: The room temperature is higher than setpoint in parameter “Start” (°C)
And: The outdoor temperature is higher than the parameter “Outdoor stop”.
And: Outdoor temperature is >2°C lower than the room/extract air temperature.
And: There were less than 60 min. heating demand between 12:00 and 23.59, in the last operation period.

3. The summer night cooling will stop if:

- The outdoor temperature drops to current value below settings in the parameter “Outdoor stop” (°C).
Or: The actual room temperature drops to current value below settings in the parameter “Stop” (°C).
Or: Actual time exceeds the time, set in parameter “Stop time”.
Or: AHU operation mode is changed to “On”, via the scheduler or manual via the HMI.
Or: The actual supply air temperature cannot be maintained above ”Min supply” setpoint.



Using Internal sensors – (or a mix of internal and external sensors)

- Enable the summer night cooling function via the activation button in the menu.
- If internal sensors are used for the outdoor- and the room temperature (*via the extract air temperature sensor*), the summer night cooling function will execute a 10 minute “**Start-up for testing**” sequence.
- The “Start-up-for-testing” sequence will only be executed once pr. night, at the time set as “Start time”
- Fan speed during “Start-up-for-testing” sequence, is set via the HMI-menu (% or m³/h)
- If all requirements (*described in above bullet #1*) for running summer night cooling is fulfilled, the AHU will continue operation in summer night cooling, until one of the requirements (*described in above bullet #2*) is fulfilled.



Note

If a mix of internal and external sensors are configured, the “Start-up-for-testing” sequence is always carried out.



Note

Is the AHU already in operation mode “Low speed”, started by the scheduler or manually selected via the HMI, the summer night cooling will be executed according to the same requirements described in above bullet #1 and stop as described in above bullet #2. After summer night cooling, the AHU will return to normal operation mode.

21. Operation time schedule

21.1 Operation modes

The AHU can have different fall back operating modes:

- √ **Stop**
 - The AHU is stopped outside the configured operation periods. The frost protection of heating coils remains active and the pump and valve motioning also remains active.
- √ **Low**: the system will run at low speed outside the configured operating periods.
- √ **Medium**: the system will run at medium speed outside the configured operating periods.
- √ **High**: the system will run at high speed outside the configured operating periods.
- √ **Extended stop**: the AHU will be stopped outside the configured operating periods.

Extended stop means:

- The system is stopped outside the configured operating periods. Frost protection of heating coils remains active and the pump and valve motioning also remain active.
- Summer night cooling will be active and the function will start the system if the preconditions for doing so are fulfilled.
- The system can be started manually via the start signal: “*High speed*” (boost speed).

The properties should be configured first (*see the next page for how to do this*).



21.2 Setting the active schedule period and fall-back speed

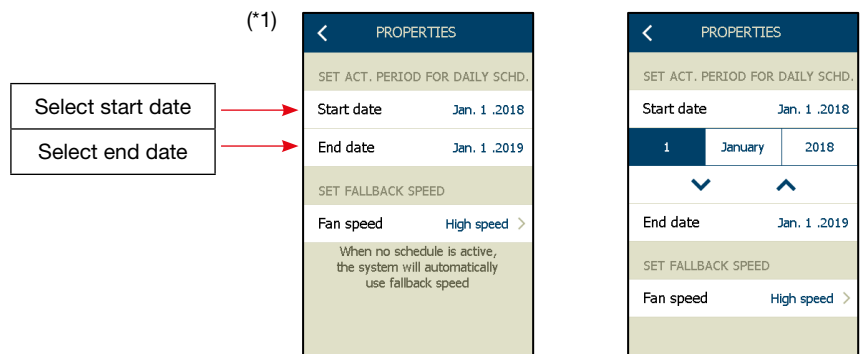
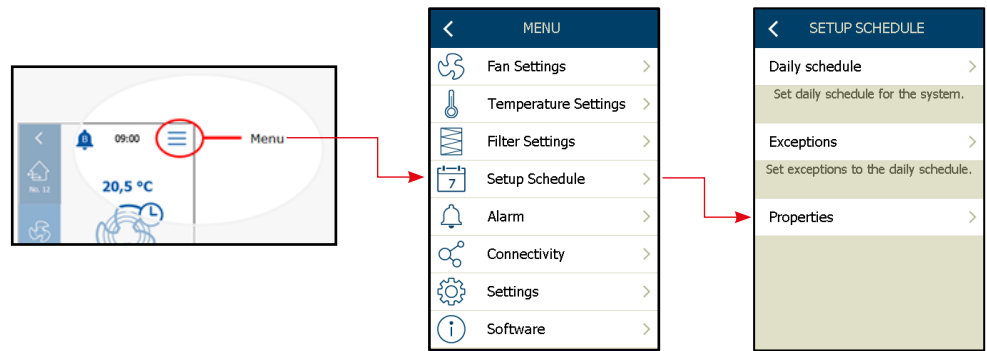

(*1):

Set the period during which the calendar programme will be active.

Here, we have selected "Setting the schedule period" = **1. January 2018**....1. January 2019****

Outside this period, the AHU will run according to the selected "fall-back speed"

(*2):

Outside this period, the selected operating mode as configured under "Fan speed" will be active.

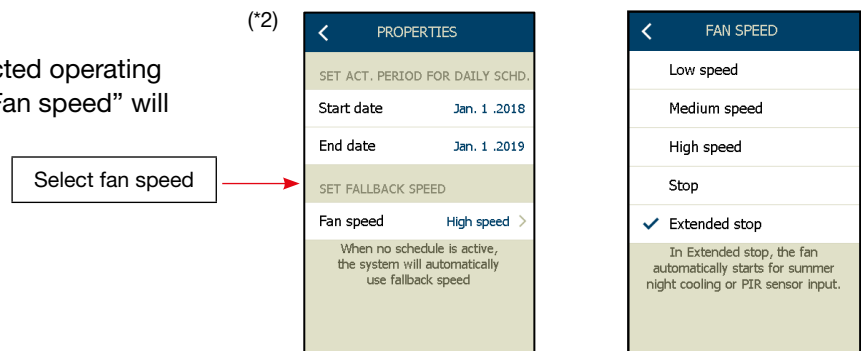

Here, we have selected "Fan speed Operation mode" = **Extended stop** (see previous page).

- Outside the selected active period for daily schedule and when no timer scheduler is active, the AHU will go into this operating mode.



21.3 Setting standard daily operation pattern

For setting the operating pattern that will be in effect.

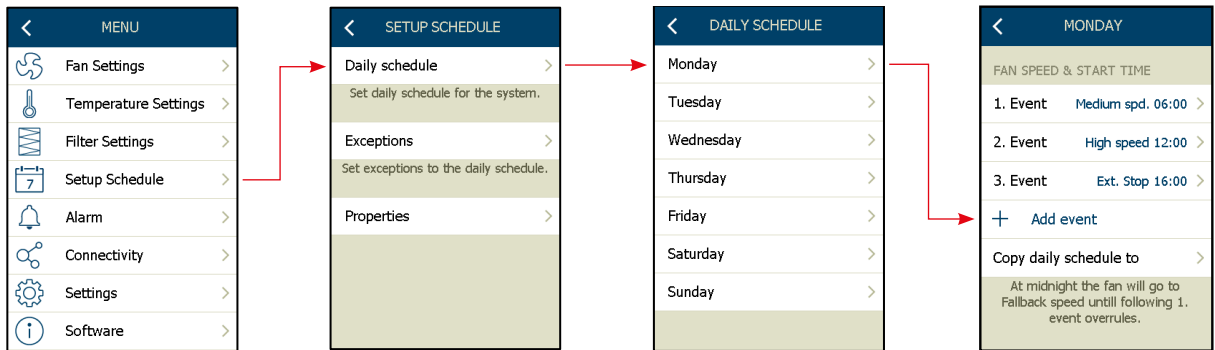

Select “Daily schedule” and in the dialogue box “Daily Schedule” choose “**Monday**” to set the operating pattern for Mondays and select “**Add event**”.

Now: For each individual time for changing the operating mode, select the operating mode that the AHU will take at this selected time.

In our example, the switching time at which the system will change its status on Mondays.

- Start at medium speed at 6.00
- Change to high speed at 12.00
- Change to extended stop at 16.00 (*fall-back speed as selected on previous page*)

Start making the first Event

The first event on Monday is to start the AHU in the morning at medium speed at 6.00.

(*1): Select “+ Add event”

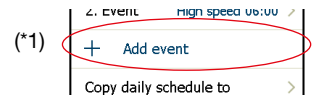

(*2): Set time (h + m) for the event

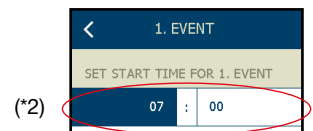

(*3): Select the fan speed of the event

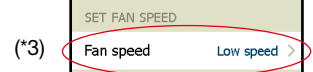

(*4): If you want to delete this current event: Press “Delete”



Repeat the steps for all the next events on Monday



21.4 Copy a daily schedule to one or more days

If the operating patterns are identical for Monday through Friday, then use the “Copy” function.

Copy Monday

- ✓ The operation schedule that has now been specified as the operating pattern for Monday will be copied to selected days.



Note

Copying functionality..!

If there are individual days that are not going to have the same operating pattern, even though you have used the copying functionality, these days can subsequently be individually changed.

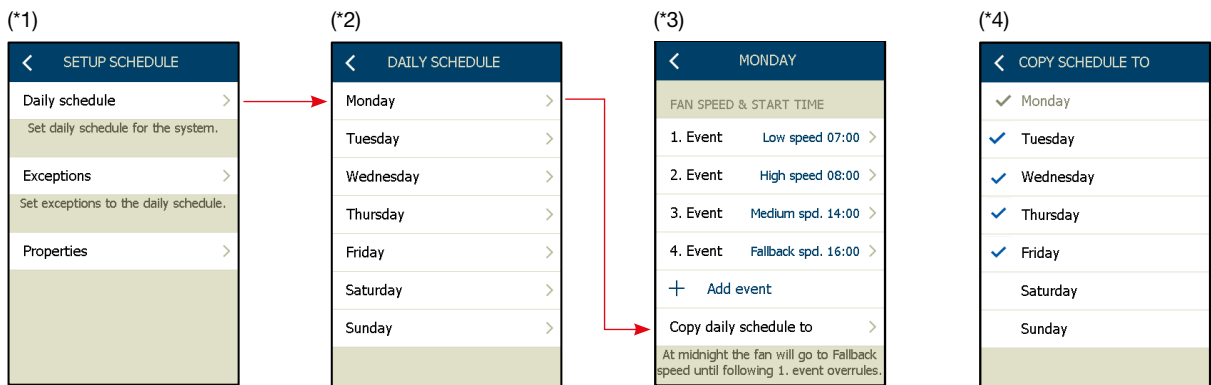

(*1): Select “Daily schedule”.

(*2): Select the daily schedule (day) that will be used as “copy from”.
Check that the events are correctly scheduled.

(*3): Press the menu “Copy daily schedule to”.

(*4): Select the weekdays with a check mark , that must use the same schedule as Monday.

Save by pressing “Back”



21.5 Scheduled operation exceptions

Setting exceptions

You may now configure the exceptions from the normal operating pattern.

It is possible to make three different exception rules and each exception rule can be used in up to 10 different periods.

This exception function may be used to make periods where the AHU must operate differently from the daily programmed schedule.

In the following example we will describe how to create an exception which is active when you want to stop the AHU during national holidays and other extraordinary closing days. Days that are an exception from the normal operation schedule. Days the building is closed and empty. During these closing days, the AHU will “keep an eye” on the room or building and start up if necessary, e.g. if the room temperature exceeds the summer night cooling setpoint.

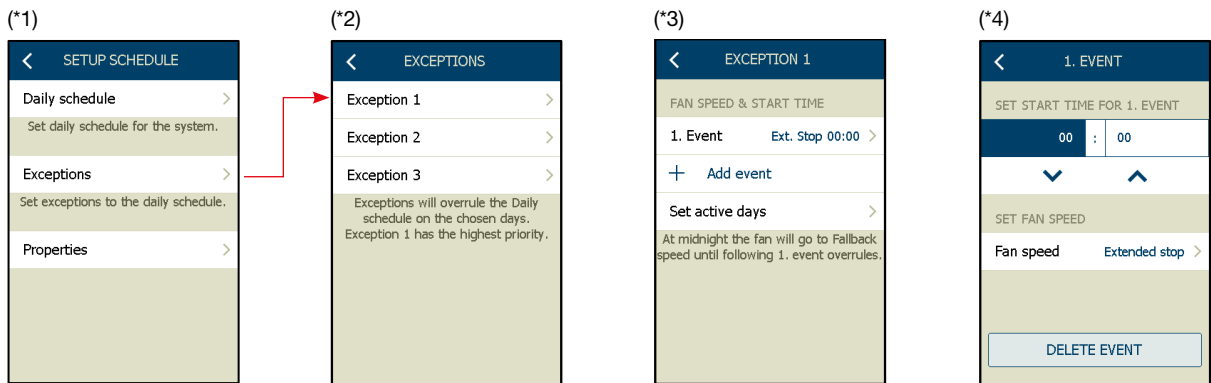

(*1): Select “Exceptions”.

(*2): Select “Exception 1”.

(*3): Press “+ Add event” to create the first event.

In this exception we will create a stop event so we will only need one event.

In this case the stop event is selected as “fall-back speed”

The fall-back speed is set under ”Properties” (*index 21.2 in this guide*)

(*4): If more events are needed, it is possible to create more events – repeat: (*3)

On the next page, we will select the period that this exception will be active.



On the previous page we set the pattern for Exception 1.

On this page, we select the days on which this Exception 1 must be activated.

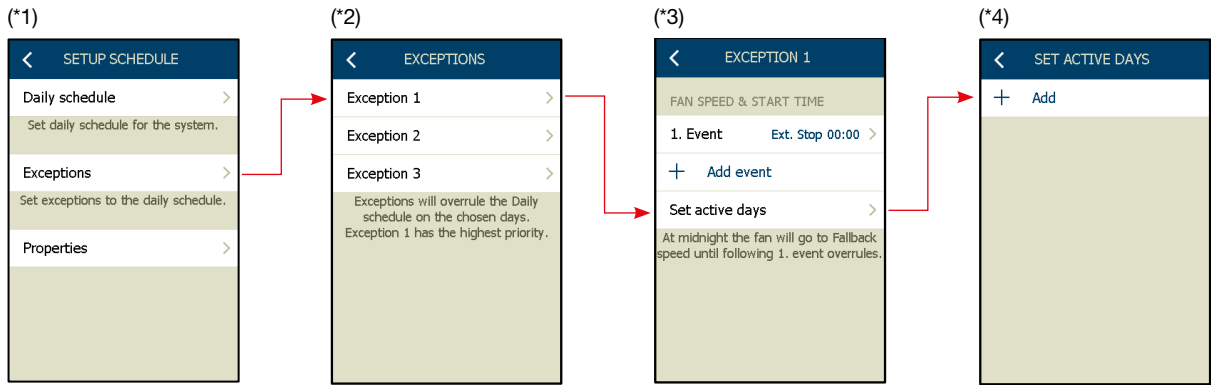

We will now make a number of time schedules when the Exception 1 must be active:

Example:

1. 5 June is a public holiday, a national closing day – day programming
2. 1 week of holiday in week 7 – week programming
3. 2 weeks of holiday from 16 July to 29 July – period programming

Activate “Exception 1” on a single active day

1. Select “+ Add” (*4) and select the date

Leave and save by pressing on .

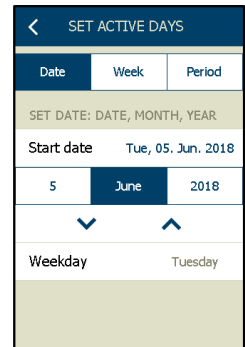

The programmed activity is now visible on the overview

It is possible to make more single-day periods:

Select “+ Add” (*4) and select more days of activation.

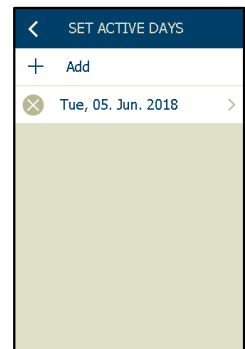



Activate “Exception 1” on a single active week.

2. Select “+ Add” (*4) and select the week

Week 7/2018 starts on the second Monday in February.

Leave and save by pressing “Back”

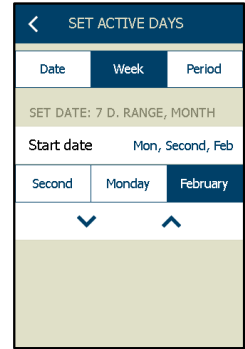

The programmed activity, is now visible on the overview

It is possible to make more single week periods:

Select “+ Add” (*4) and select more days of activation.

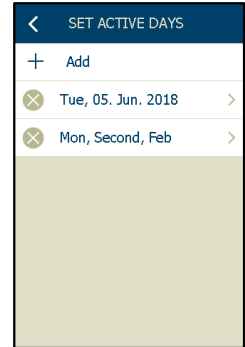

Activate “Exception 1” in a free selectable period.

1. Select “+ Add” (*4) and select the week

2 weeks of holiday starts on 16 July and ends on 29 July. 2018

Leave and save by pressing on

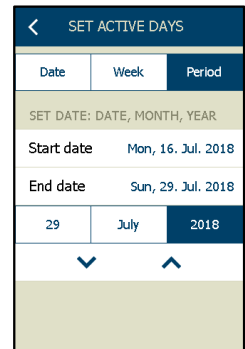

The programmed activity is now visible on the overview

It is possible to make more freely selectable periods:

Select “+ Add” (*4) and select more days of activation.

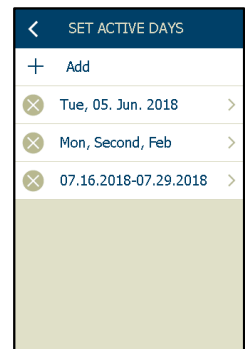



22. BasicBMS

22.1 Introduction

The BasicBMS solution allows the user to access and monitor multiple Air Handling Units in up to 25 individual rooms using a single AHC-3000-HMI-35T.

When the AHC-3000-HMI-35T is connected to the AHC-3000 controller operating as a BasicBMS Building Master, the user will be able to access, control and monitor all Air Handling Units in the BasicBMS network.

Up to 14 Air Handling Units in each room can be connected as satellites, each of them following the BasicBMS Room Master setpoints and operation modes.

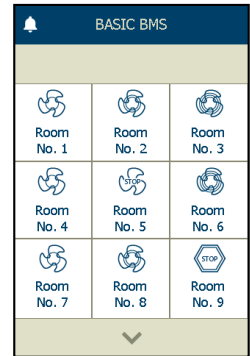

22.2 Configuring BasicBMS Building Master network

To configure a BasicBMS Building Master network, you must start making an overview over the entire network, included in the BasicBMS system. Make a drawing or similar to get an overview. Start pointing out which AHC-3000 controller assigned as being the Building Master and make a plan for addressing all the AHC-3000 controllers, in the BasicBMS Building Master system.

Room No.	BasicBMS Info	Location
1	Building Master having HMI xx Satellites	Janitor office
2	xx Satellites	Classroom 100
3	xx Satellites	Classroom 101
4

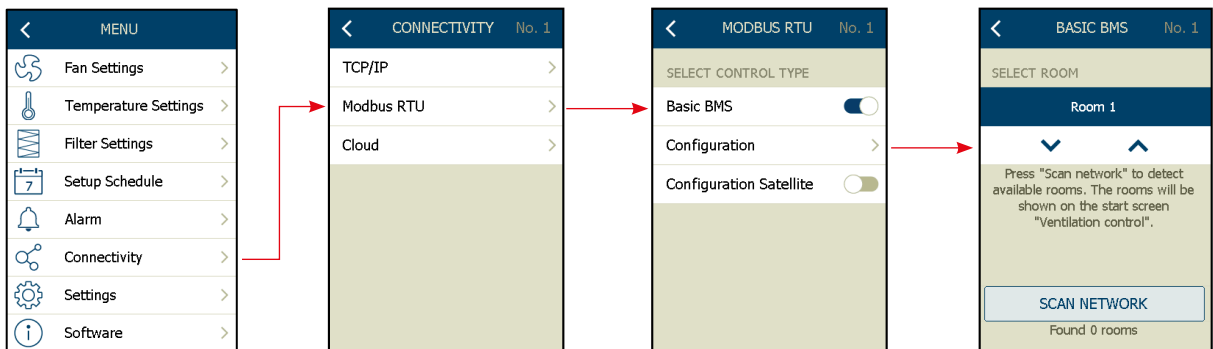

- Always start by configuring the first Air Handling Unit as the BasicBMS Building Master, as described below:

- ✓ Disconnect the Modbus communication cable from the “BMS Modbus 485 plug” on the BasicBMS Building Master.
- ✓ Connect the AHC-3000-HMI-35T to the BasicBMS Building Master.
- ✓ Select “Menu”
- ✓ Select “Connectivity”
- ✓ Select “Modbus RTU”
- ✓ Activate the “BasicBMS” button
- ✓ A new menu will now appear “Configuration”
- ✓ Press “Configuration” button
- ✓ The Building Master is addressed as “Room 1”
- ✓ Press “Back”



Note

Do not press the “Scan network”!
Do not reconnect the communication cable into the “BMS Modbus 485 plug” on the BasicBMS **Building Master**.

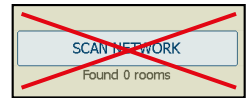

- Now continue configuring the other Air Handling Units as **room controllers**, as illustrated below:

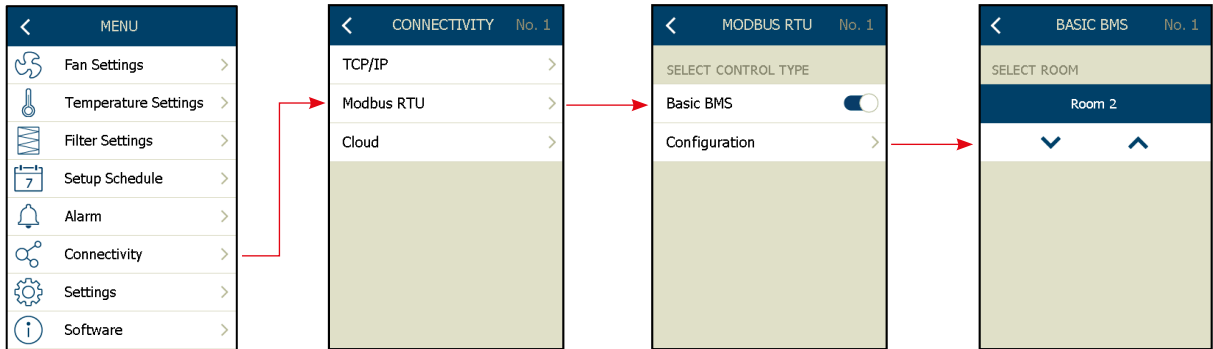

- ✓ Plug the AHC-3000-HMI-35T into the Air Handling unit in the next room.
- ✓ Select “Menu”
- ✓ Select “Connectivity”
- ✓ Select “Modbus RTU”
- ✓ Activate the “BasicBMS” button
- ✓ A new menu “Configuration” will now appear.
- ✓ Activate the “Configuration” button
- ✓ The first room controller, after the Building Master, is addressed as “Room 2”
- ✓ Press “Back” – the setting is autosaved.
- ✓ Correct any pending A-Alarms
- ✓ Check the BMS Modbus network wiring in accordance with the AHC-3000 instructions. See fig. 15 and 16.

- Now continue configuring the rest of BasicBMS Room controllers, plugging the HMI into each Air Handling Unit as described above.
- The maximum number of rooms in a BasicBMS network is 25 rooms, including the BasicBMS Building Master.



Note

All AHC-3000 controllers in the network must have different individual room numbers. If two or more AHC-3000 controllers are setup with the same room number, the network will not function.



22.3 Finishing the Modbus communication network

After all of the AHC-3000 controllers in the entire network have been given individual addresses, reconnect the connection cable into the “BMS Modbus 485 plug” on the BasicBMS Building Master.

After ensuring that all Modbus connections are properly connected, return to the Air Handling Unit assigned as BasicBMS Building Master. (Room no. 1)

Now start the ”Scan Network” process, according to the process below:

- ✓ Plug the AHC-3000-HMI-35T into the BasicBMS Building Master.
- ✓ Select “Room No.1”
- ✓ Select “Service stop” on the main screen
- ✓ Select “Menu”
- ✓ Select “Connectivity”
- ✓ Select “Modbus RTU”
- ✓ Select the “Configuration” button
- ✓ Activate the “Scan network” button
- ✓ The text “Found xx rooms” below the “Scan network” button will be updated within 10 seconds after the scan is completed.
- ✓ All the connected room controllers will now be set to “Service stop” mode.
- ✓ Press “Back” – until “Home screen” is displayed
- ✓ On the home screen on the BasicBMS Building Master, wait until the automatic SW update is complete* (The SW update is now in progress)
- ✓ Because the SW-package contains 4 files, the 0..100% is shown up to 4 times *
- The network SW update takes less than 10 minutes to complete.
- ✓ During the SW-update, the “Home screen”, on the BasicBMS Building Master, is locked *

* = Only if some Air Handling Units in the network have a different SW version than the BasicBMS Room Master.



Note

Software update

If you want to make an SW update, now or later, only the BasicBMS Building Master will need to be updated. All of the connected Air Handling Units/Room Masters, will be updated automatically after the SW update process has finished, on the BasicBMS Building Master.

The SW update progress (%) can be followed on the AHC-3000-HMI-35T display.

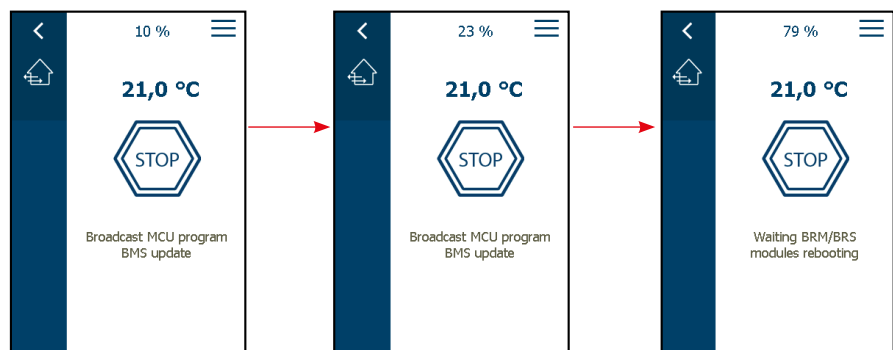

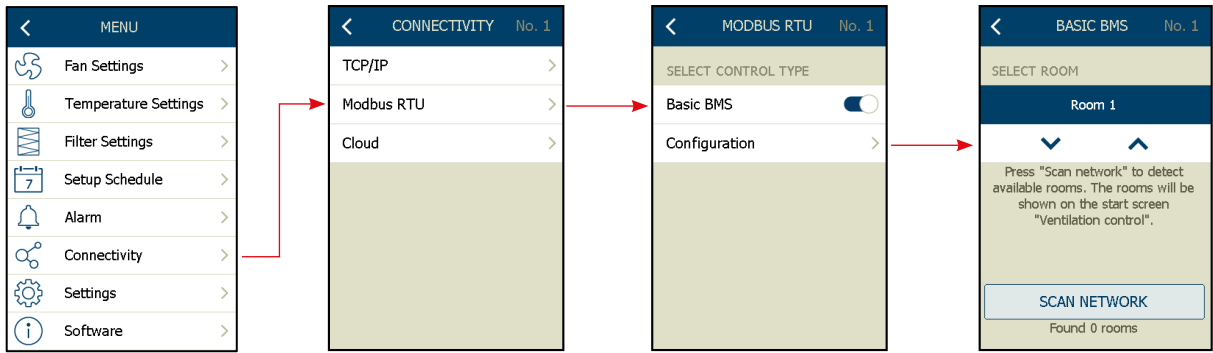

- ✓ When the SW-update process is finished, the BasicBMS system is ready to use.
- ✓ Press “Back” and the AHC-3000-HMI-35T will display the connected room numbers and their individual operating mode.
- ✓ The screen provides you with a quick overview of the complete network, displaying current ventilation speeds and alarms.
- ✓ Detailed information for each room is accessible by touching the panels’ room numbers.

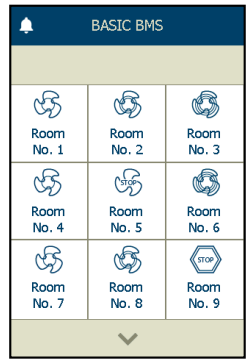

Note

All of the connected room controllers will remain in “Service stop” mode until their operating mode is changed individually via the AHC-3000-HMI-35T.

22.4 Common outdoor sensor

The common outdoor sensor, TTH-6040-O, must be connected to the Building Master port ”A”. On the Building Master, you must activate ”Autoconfigure” to integrate the TTH-6040-O. If a common external outdoor sensor is connected to the Building Master, the current outdoor temperature, will be broadcasted to all connected Room Master(s) and the connected Satellites.

22.5 Setting up all Schedulers

The most efficient way to setup the Schedulers for all of the Air Handling Units in the BasicBMS network is to follow this procedure:

- ✓ Set up the scheduler on the Building Master Room no. 1, including Exceptions and Properties.
- ✓ Activate the “COPY” button in order to copy the scheduler settings to all rooms in the network.
- ✓ Fine tune the Scheduler settings in individual rooms if some of them need different settings.

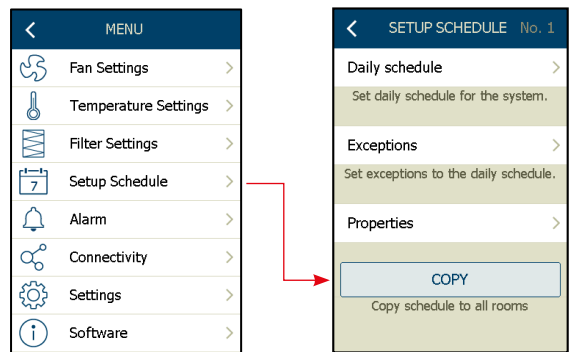

Note

Press the “COPY” button to overwrite any individual room scheduler settings in the entire network. Copy Schedule to all rooms is only available from the BasicBMS Room Master (Room no. 1)



22.6 Configuring the BMS Satellites network

The Basic BMS-Satellite function coordinates the operation of up to 15 decentralized AHU in each room.

The main AHU in a room is connected to the Basic BMS network and operates as AHU Room Master. Up to 14 AHU's can be connected as satellites to the AHU Room Master.

The operation of all AHU satellites is coordinated and controlled by the AHU Room Master. AHU Satellites can be connected to:

- Building Master (BM) or
- Room Master (RM).

AHU Satellites can be connected to the Building Master and/or the Room Master.

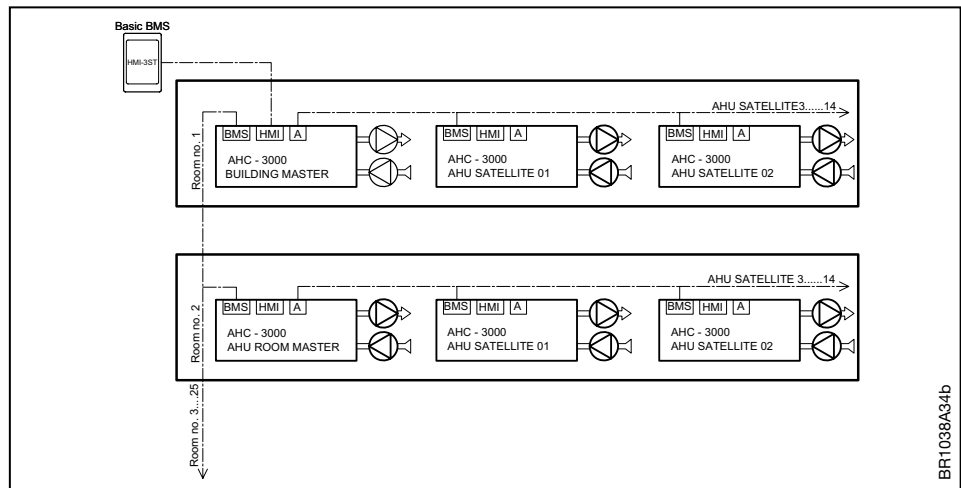

Further information on the electrical installation: See technical instructions.

22.7 Configure the AHU Satellites

- Start always configuring the AHU Satellites.
- AHU Satellites shall have AHC-3000-T/-S/-B controllers.
- In the sample below, the AHU Satellites are AHC-3000-S controllers.

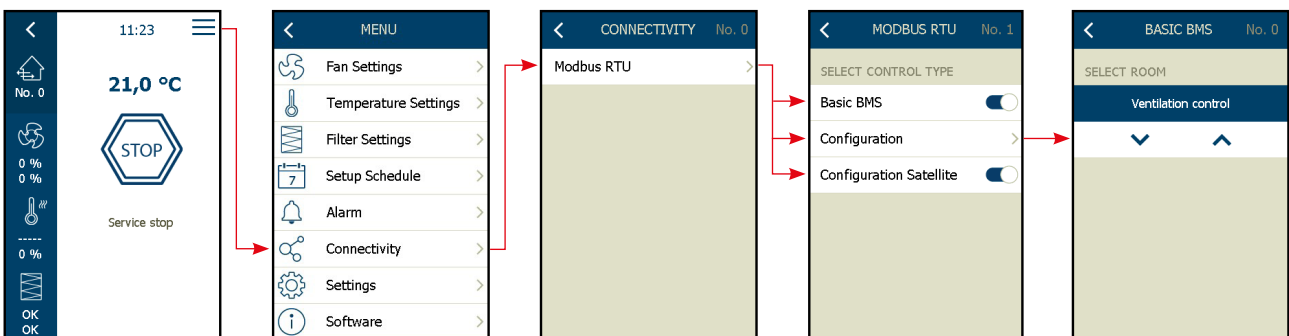

- Connect the AHC-3000-HMI-35-T to the first AHU Satellite
- Select "Menu"
- Select "Connectivity" from the menu list
- Select "Modbus RTU" *
- Activate "Basic BMS" button
- Activate "Satellite" button
- Check the selection in the "Configuration" menu: Must display "Ventilation control"
- Continue same process to the next AHC-3000 Satellite

* = Sample is built on AHC-3000-S and that's why only "Modbus RTU" is visual in the menu.



22.8 Configure the AHU Satellites to the Building Master (BM) / Room Master (RM)

Building Master / Room Master shall have AHC-3000-T/-B controllers.

In configurations where the Satellites are connected to the Room Master (RM)

1. Connect the AHC-3000-HMI-35T to the Room Master, on which the Modbus to the AHU Satellites are connected.
2. Select “Menu” -> “Connectivity” -> “Modbus RTU”
3. Check “Satellite” button = Shall be in position = “Off”

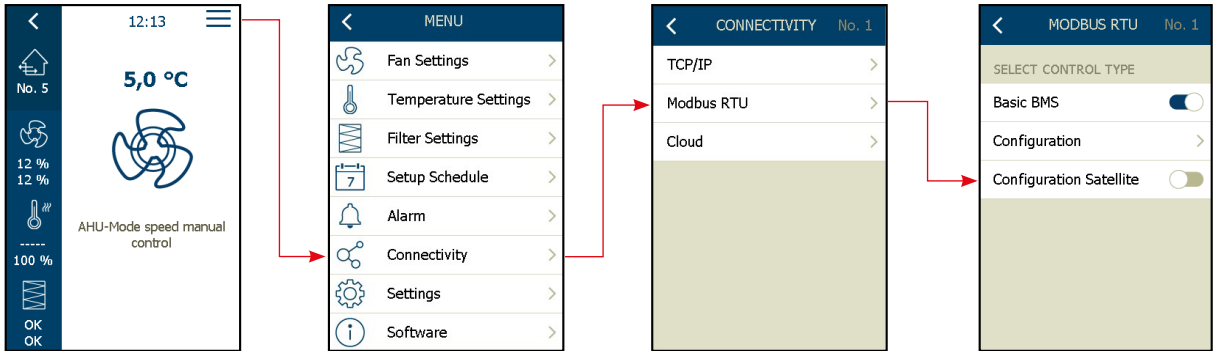

In configurations where the Satellites are connected to the Building Master (BM)

4. Connected the AHC-3000-HMI-35T to the Building Master, on which the Modbus to the AHU Satellites are connected.
5. Select “Menu”
6. Select “Connectivity” -> “Modbus RTU” -> “Configuration” from the menu list
7. Press “SCAN NETWORK” and the connected RM, incl. Satellites are found and listed.

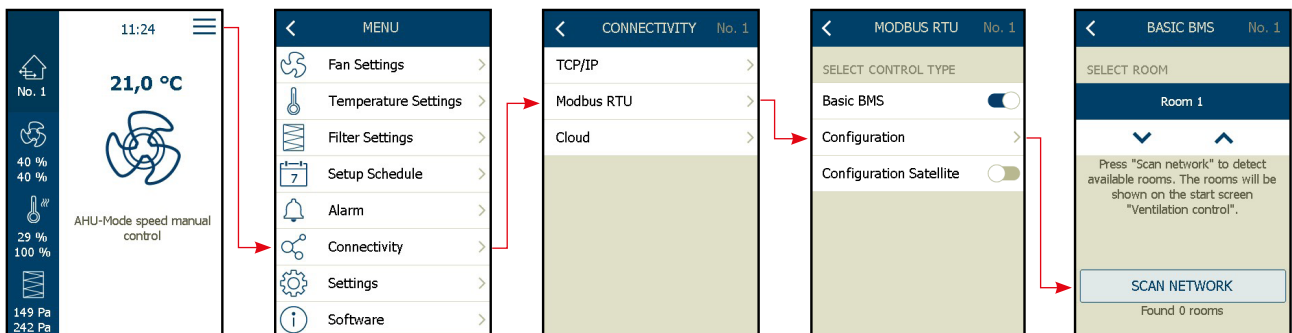

22.9 Allocation of satellite numbers

During the “Scan Network” process, the AHC-3000 satellites will automatic be allocated a unique satellite number, according to the individual AHC-3000 HW production number. AHC-3000 HW production number is also printed on the silver label, placed on the right side on the AHC-3000 controller.

The highest production number in the satellite network, will be allocated “Satellite no. 1”.

1. Qualifier: Year + Week
2. Qualifier: Order number
3. Qualifier: Batch

Prod. Code sample 21:102357:0007:11 = **(Year) : (Order number) : (Batch) : (Week no.)**

Year	Order number	Batch	Week	Allocated Satellite no.
21	102357	0007	11	1
20	97258	0006	29	2
20	97258	0005	29	3
19	87529	0014	37	4



22.10 SW update process

If the current SW vers., on the connected AHU Satellites, are different version than the Building Master / Room Master SW vers., the update process will automatic activated.

The current SW version on the AHU Building Master / Room Master, will be broadcasted to the connected AHU Building Master / Room Master (s) and their connected AHU Satellite(s), via the Modbus connection.

If an SW-update is needed, you only need to download the new SW into the AHU Building Master. The update of the connected AHU Room Masters and the connected AHU Satellites, will automatic be broadcasted to the connected AHU Room Master(s) and connected AHU Satellite(s), via the Modbus connection.

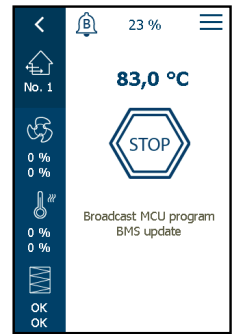

When the LED, placed on the PCB just in connection to the power terminals (45 & 46), is flashing red, the AHC-3000 is in update process, the operation mode is forced in “Service Stop”. When the LED, flashes green again, the update of the connected AHU Room Master(s) and connected AHU Satellite(s), has finished.

During the update process, the current status of the update process can be followed via status text and a %-symbol, displayed in the top of the HMI-35-T.

When the update process has finished, the connected AHC-3000, will return to the actual operation mode that was present, at the time when the update process was started.

22.11 How to delete a AHU Satellite from the network

If an AHU Satellite is taken out of duty, it shall be deleted from the Modbus network. The AHU Satellite must be deleted according to this process:

1. Connect the AHC-3000-HMI-35 to the AHU Satellite, which are to be taken out of duty.
2. Select “Menu”
3. Select “Connectivity”
4. Select “Modbus RTU”
5. In the menu “Configuration Satellite”, de-activate the button to position “Off”
6. In the menu “Basic BMS”, de-activate the button to position “Off”
7. You can now power off the AHU Satellite and build-out the AHC-3000 AHU Satellite

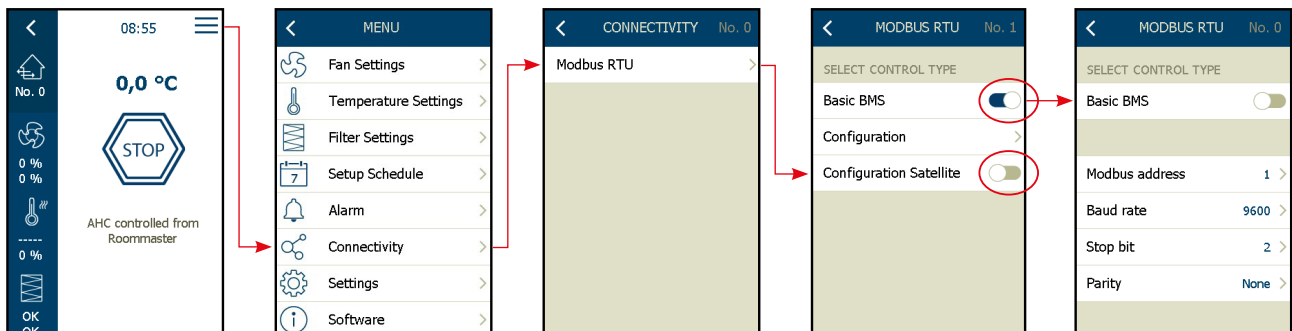

(To be continued next page...)

(Continued from previous page)

8. Connect the AHC-3000-HMI-35 to the Building Master (BM)
9. Select “Menu”
10. Select “Connectivity”
11. Select “Modbus RTU”
12. Select “Configuration”
13. Press “Scan Network”
14. Wait until all AHU Building Room Master* and AHU Room Master(s)* are found again
 *=(Rooms=Not the number of AHU Satellites)

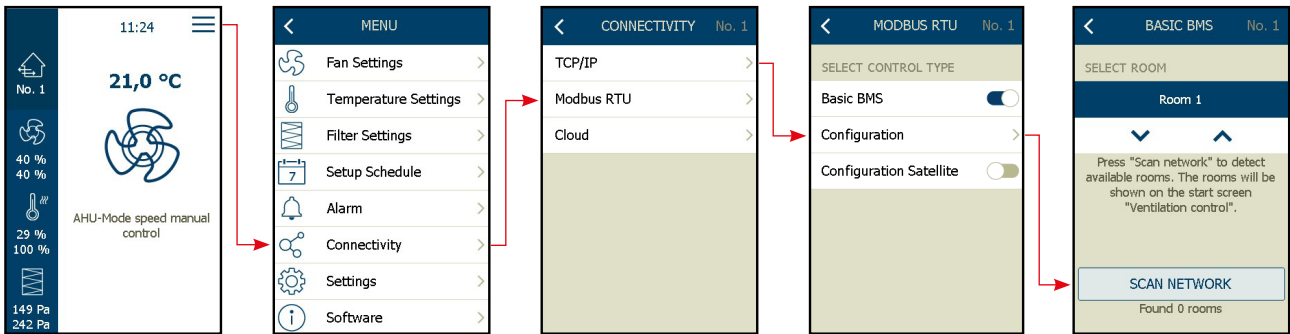

22.12 How to add a new AHU Satellite to the network

Follow the process as described under index 22.6, in this manual.

22.13 Satellite control settings

In the AHU Room Master:

Configuring the application - according index 14.xx to 17.xx in this Commissioning Guide.
 Select the control settings for:

- Temperature control – according index 20.xx in this Commissioning Guide
- Fan control – according index 19.xx in this Commissioning Guide
- Operation time schedule – according index 21.xx in this Commissioning Guide

In the AHU Satellite(s):

Configuring the application - according index 14.xx to 17.xx in this Commissioning Guide.
 Below settings cannot be changed in the AHU Satellites:

- Temperature control* in the AHU Satellites are forced into “Constant supply air temp.”
- Fan control* in the AHU Satellites are forced into “Constant fan speed.”
- Operation time scheduler* – The AHU Satellites are operated according to the time scheduler in the AHU Room Master. No scheduler time selection has to be made in the Satellites.

*= Cannot be changed in the AHU Satellites.

(To be continued next page...)

(Continued from previous page)

22.14 Alarm handling from the AHU Satellites

All alarms from the AHU Satellites will be displayed on the “Tiles overview” on the HMI-35T, connected to the AHU Building Master.

Every single tile is allocated to a specific room. If one or more alarms are activated, the symbol on the single tile, will be displayed with a bell symbol and an indication on the type of alarm is triggered in the room.

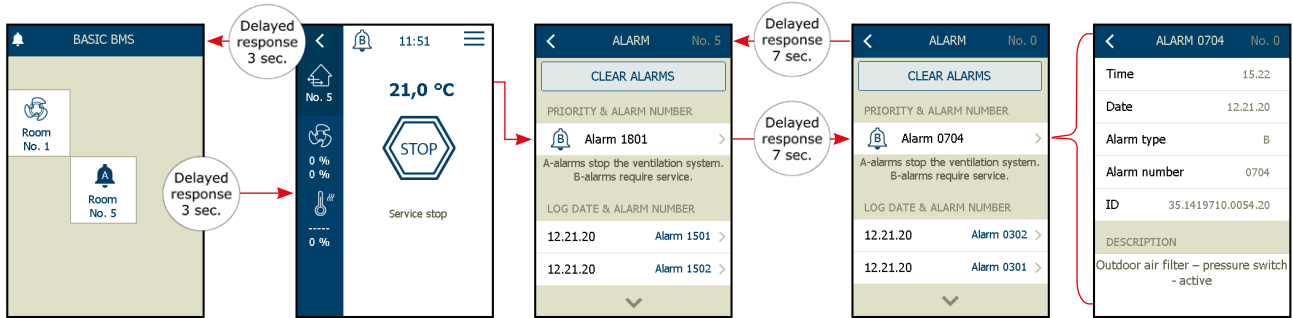

To read out and to reset the alarm in the connected room, follow the process below:

1. Select the brick (Room number) on the “Brick overview” on the HMI-35T
2. You will now be connected to the actual AHU Room Master – 3 sec. delayed response
3. Select by click the alarm bell in the top of the display
4. Now the alarm number is presented – see Alarmlist for more information
5. Select the actual alarm you want to read out
6. If the activated alarm is from one of the AHU Satellites, only visible text is that an alarm is activated in Satellite no. XX
7. In the sample above, the “Alarm 1801”, is displayed. This means that we have an active alarm from “Satellite no. 1”
8. To read out and to reset alarms from a AHU Satellite, you click the alarm number and after 7 sec. delayed response time, you are now connected to the actual satellite.
9. From this window, you can read out and reset the alarm in the actual AHU Satellite. If you enter the single alarm, you will find information of the “ID number” on the actual Satellite.
10. Connection between “ID number” and “Satellite number” is described under index 22.8.

To read out alarms and reset alarms, if the AHC-3000-HMI35-T is connected to a Satellite, follow the process below:

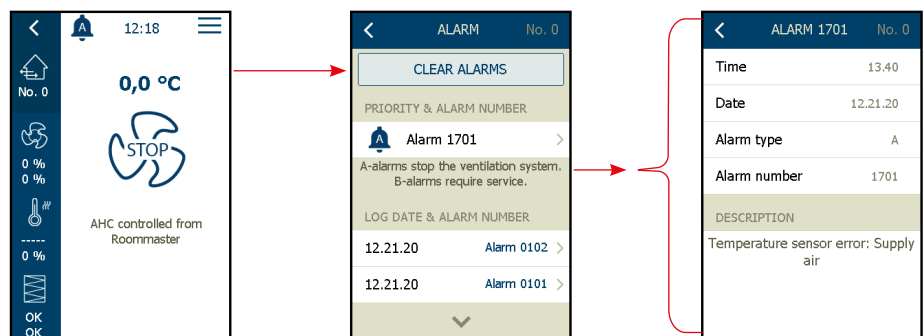

1. Connect the HMI-35T to the actual AHU Satellite no.X
2. Select by click the alarm bell in the top of the display
3. Click the actual alarm you want to read out
4. The activated alarm is now displayed with alarm text, date & time, alarm type.
5. Repair the cause of the activated alarm - Press “Clear alarms”

OJ Electronics A/S
Stenager 13B • DK-6400 Sønderborg
Tel. : +45 73 12 13 14 • Fax +45 73 12 13 13
oj@ojelectronics.com • www.ojelectronics.com